

\$500 Gold for Solution of Mystery

Radio Digest

EVERY
WEEK

Illustrated

TEN
CENTS

Vol. XVI No. 7

Copyright 1926 by
Radio Digest Publishing Co.

Title Reg. U. S.
Pat. Off. &
Dom. of Canada

FEBRUARY 20, 1926



"The Voice of Porto Rico" Tells a Story; WJAG Birthday Party; Women's Programs; Uncle Sam Aids Rural Radio; Announce Foreign Test Winners; How to Stop Blooping

DEMANDS STATIONS LABEL ADVERTISING

WOULD AVOID FOISTING OF PUBLICITY ON PUBLIC

Rep. Emmanuel Celler Asks for Same Regulations of Ether as Those Governing Newspapers

WASHINGTON.—“This is BLAA, broadcasting station of the Giant Peanut company, Newark, N. J. You will now have the pleasure of listening to the Walk-Up-One-Flight Clothing company's orchestra. Their first number will be, 'You Don't Wear Them Out If You Don't Sit Down.' Should any of our Radio fans desire to communicate with the Walk-Up-One-Flight Clothing company's orchestra they can do so by communicating with Station BLAA.

“This is SPOOF station, Chicago, Ill. You have just listened to Mr. B. Fuddled, of the Lone Star Ham company, in his interesting talk on ‘Tid-bits and Why Delicious Lone Star Ham Should Be on Every Table.’

“Those of you who relish a good cigar will be delighted to hear that our next number will be a song, ‘Rings of Smoke,’ to be rendered by Mr. Jack A. Napes, general sales manager of the Amalgamated Cigar Stores company. We ask our Radio fans to remember the Amalgamated Cigar Stores company because it will have one of its employes perform for us every Monday night.’

Congressman Indicts Advertising

“You have just heard Mr. Jack A. Napes. SPOOF now signs off for the night after announcing that at 3:45 tomorrow afternoon every housewife will welcome Mrs. Laura New of the Durable Pancake company, who will give helpful lessons on ‘How to Make Flapdoodles Out of Sawdust.’”

The above is merely a reproduction of what Representative Emmanuel Celler of New York has caused recently to be published in the Congressional Record. Representative Celler's tirade is most interesting. He does not believe in advertising broadcasts as they are done today, and he frankly says so.

Newspapers Must Label Ads

“It is illegal for newspapers or magazines to publish advertising without letting their readers know that the matter is paid for and is advertising. The reason for this was to avoid the foisting of disguised advertising matter ‘as reading notices’ or news. The law was adopted to avoid this public imposition and deception.

“Broadcasting of paid-for or indirect advertising without a statement that the matter has been paid for, is no less deceptive and an imposition. Those of you who are familiar with Radio activities or are listeners often have recognized this scheme of deceptive advertising.

“The Radio bill introduced by Mr. White, the gentleman from Maine, and which is now being considered by the committee on the merchant marine and fisheries, in section 5 very rightfully provides as follows:

White Bill Protects Listeners

“All matters broadcast by any Radio station for which service, money or any other valuable consideration is directly or indirectly paid or promised to or charged or accepted by, the station so broadcasting shall be announced as ‘advertising’ at the time the same is so broadcast: Provided, that when the advertisement or publicity sought consists solely of the announcement of the name, business, and address of the person, firm, company, or corporation paying for the feature broadcast, it shall be sufficient to announce that such feature broadcast is ‘paid for or furnished by’ such person, firm, company or corporation.”

Station Changes

Here is Florida with another broadcaster, the new municipal station of Pensacola, WCOA. On a wave length of 222 meters, the first program from this studio went out over the ether for the first time Wednesday evening, February 3. The announcer is John E. Frenkel.

The thud of boxing gloves, the scraping of skates on the ice during hockey matches and other familiar sounds from Madison Square Garden preceded by the call WMSG, will be heard the first part of this week. A low wave length of 212.6 meters prevents any interference with New York stations already on the air.

The following stations were deleted last month: WGBK, Johnstown, Pa.; WDCH, Hanover, N. H.; KFGH, Stanford University, Calif.; KFOJ, Moberly, Mo.; WTAC, Johnstown, Pa.; WJBN, Sycamore, Ill.; WIBC, St. Petersburg, Fla.

WILSON WETHERBEE IS VETERAN OF KYW

CHICAGO.—Saturday, February 20, marks the completion of four years of Radio service of Wilson Wetherbee, director of Westinghouse Station KYW. Having come to the station when



Wilson Wetherbee

KYW was barely four months old, he has witnessed its growth practically from its cradle days.

Born in Elkhart, Ind., in 1900, educated in its schools and later taking studies pursuant to a literary career, Mr. Wetherbee soon after found himself on the staff of the Elkhart Daily Review.

The world was treating “Scoop” Wetherbee fairly well. The South Bend Tribune felt the need of the services of an enterprising young man, so to South Bend he went. From the South Bend Tribune “Scoop” went to the South Bend Times, shortly after which he went back to school to study at the University of Chicago. However, campus rules did not agree entirely and the call of the press brought him to the editorial staff of the Chicago Daily News. He remained there just about a year when the wild idea of

WAMPAS BEAUTY IS GIRL ON OUR COVER

FAY WRAY—sounds almost like “Fairy,” doesn't it?

That's the name of the exquisite maiden on the Radio Digest cover this week. And, of course, she just naturally lives in Hollywood, Calif., with the rest of the 1926 crop of WAMPAS beauties who made their grand debut at the frolic in the new Al Malukah shrine temple in Los Angeles on February 4.

There were thirteen of these little “Wampies” and from a picture in our last week's issue it seems Miss Fay is the only one who didn't have the heart to snip the wandering tendrils from her crown of glory.

All the Wampas stars were presented to Radio listeners over KNX, during a special Radio reception.

“Radio” brought him to KYW to take the position of assistant director. On May 1, 1922, “Scoop” was appointed director of the station which position he still holds.

Imagine Chicago's pioneer station four years ago. A personnel of only three or four members; one studio; the technique of Radio fairly unknown and little thought of. If artists did not appear, they just pushed a convenient phonograph up to the “mike.” Those were only a few of the griefs of Radio life four years ago. The director had to not only conduct the activities of the station, but he had to seek talent, answer kicks, do the announcing, look happy and when no one was looking, sweep the floor.

CONTENTS

Radio Digest, Illustrated, Volume XVI, Number 7, published Chicago, Illinois, February 20, 1926. Published weekly by Radio Digest Publishing Co. (Incorporated), 510 N. Dearborn Street, Chicago, Illinois. Subscription rates yearly, Five Dollars; Foreign Postage One Dollar additional; single copies Ten Cents. Entered as second class matter at the post office at Chicago, Illinois, under the Act of March 3, 1879.

All the Live News of Radio.....	1 to 11
Uncle Sam Aids Rural Radio with Farm Broadcasts.....	4
Let's Go, WJAG Throws a Party.....	5
KMA Lives Up to Slogan, “Keeps Millions Advised”.....	6
WKAO, “The Voice of Porto Rico”.....	7
Women's Page; Index to Women's Programs.....	11
An Evening at Home with the Listener In; a chart in Eastern Time, showing when to listen in for stations.....	12
Advance Programs for the Week.....	13 to 21
Editorials, Indi-Gest and Condensed by Dielectric.....	22
A. B. C. Fundamentals for Everybody, Chapter VII—Radio Frequency Amplification, by Milo Gurney.....	23
How to Stop Blooming and Man-Made Static, Part II—How and Why Circuits Bloop, by the Technical Staff.....	25
Two Tube, Short Wave, 15-130 Meter Receiver, Part II—Drilling and Assembling, by John G. Ryan.....	27
Reader's View.....	29
Directory of Radiophone Broadcasting Stations, Part III (Revised).....	31

Looking Ahead

Mystery, Murder, Undying Love—the special Radio mystery story by a world-famous author, Robert J. Casey, begins with the next issue. \$500 awaits the winning solutions. Don't miss the important announcements and the beginning chapter of this thriller.

February Twentieth Is a Big Day in the Regions of the Arctic Circle. Old Sol peeps over the horizon for the first time after an absence of 135 days. The Canadian “Mounties” and other human beings celebrate. Superpower stations of the United States broadcast special programs. Story and pictures here next week.

Dizzy Izzy, Musing Over a Bowl of Loco Weed Soup and a dish of purple berries from the wild asparagus, decided that the one thing Station WOAW, Omaha, needed was a “Blah Club.” Whereupon he called together certain members of the staff and a directorate was selected. You should hear Izzy tell about it in the next issue.

The Campaign Against Blooming, having fixed the blame, rubbed it in and shown how nearly all sets bloop, will next week tell of better operation of sets for more DX and less squealing. Come on, do more thinking about your own blooming and less tramping about the other fellow's!

Those Interested in Short Waves, and who are building the two tube 15-130 meter set, will find its construction carried into the wiring next week.

Operation of the King 5-Tube Tuned R.F. Set is now being studied by the technical staff and an article on it will appear next in the Operating and Trouble Shooting series.

Newsstands Don't Always Have One Left

WHEN YOU WANT

Radio Digest

YOU WANT IT!

BE SURE OF YOUR WEEKLY COPY BY SUBSCRIBING NOW

SEND IN THE BLANK TODAY

Publisher Radio Digest, 510 N. Dearborn St., Chicago, Illinois.

Please find enclosed check M. O. for Five Dollars (Six, Foreign) for One Year's Subscription to Radio Digest, Illustrated.

Name

Address

City..... State.....

NEWS BRIEFS FROM THE BROADCASTERS

PARTY NIGHT ONCE EACH MONTH FOR WRVA FANS

Famous Violinist at KGO—Learn Charleston at WMBB—Canadian Broadcasters Meet at Toronto

The first Thursday of each month will be party night at WRVA, Richmond. For three hours this southern broadcaster will give a program of dance music, so that fans can plan parties ahead of time for this night. The music will be furnished by the Richmond Hotel Winter Garden orchestra, under the direction of Billy Boyle, and will begin at 9:30 p. m., Eastern time.

One of the greatest violinists, Mishel Piastro, concertmaster of the San Francisco Symphony orchestra, will give a recital over KGO, Oakland, Tuesday night, February 23. Altogether he will play ten numbers. His accompanist will be Lev Shorr, brilliant Russian pianist.

Instructions in the “Charleston” by Prof. Thomas Sheehy are going out over the ether every Wednesday evening from WMBB, Chicago.

The first meeting of the Canadian Association of Broadcasters was held last month in Toronto. Jacques N. Cartier, director of CKAC, La Presse, Montreal, was elected president of the organization.

A new series of classical concerts will be given weekly at KYW called the Federal Master artists program. These programs will be broadcast from the Commonwealth-Edison studio every Friday night at 9 p. m. Central time. Margery Maxwell, soprano member of the Chicago Civic Opera company, was one of the artists participating in the first musicale.

Children's stories, told with an orchestral accompaniment, have been introduced to the Radio audience of the Capital by Daniel Chwalow, conductor of the Hotel Hamilton orchestra, through Station WRC, of Washington. The stories are told by Madge Tucker and are given suitable musical background by orchestral arrangement of folk songs.

O. H. Becker, the senior announcer at WGR, Buffalo, has resigned and Kenneth Fickett, who has become well known during the last two years to WGR fans, is now senior announcer. George C. Hardy is now associated with Mr. Fickett as assistant announcer.

Bulwer Lytton's powerful drama, “Richelieu,” will be broadcast by the KGO players Thursday night, February 25. Wilda Wilson Church will direct sixteen players in the technique of the audio drama before the microphones.

Thousands of old-time songs have been received from all parts of the country by the Crosley Burnt Corkers, an organization of minstrels which broadcasts Tuesday evenings through the WLW station. Many of these songs are used in the hour program.

A junior Radio club is the latest feature at WBAL, Baltimore. Hazel Knox, who has charge of the children's programs broadcast every Monday and Thursday, will direct the activities.

Rev. John Edwin Price of the First Universalist church will give a series of ethical studies of the modern drama every Thursday afternoon at 2 p. m. Central time, through WLW, Cincinnati.

Captain Daddy Long Legs will be in command Friday of the WGP Ship o' Dreams with a wealth of instructive songs and stories for the kiddies. The children of the American Revolution will be passengers to help celebrate Washington's Birthday. At 8 p. m. Eastern time, the Hon. William H. Smathers of Atlantic City will give a patriotic address.

A departure from the usual dinner concert program introduced by Daniel Chwalow, conductor of the Hotel Hamilton orchestra, is the presentation of movements of the world's greatest symphonies during the dinner hour. The playing recently of Haydn's “Surprise Symphony” as a part of a dinner program brought a greater number of applause cards and letters than any dinner concert program ever broadcast from the capital.

Parents and teachers will be interested in the lecture, “Poetry in Relation to Childhood,” to be given Friday by Mrs. Austin S. Basten, publicity chairman of the Connecticut Congress of Parents and Teachers. This talk is one of a series of educational lectures.

\$500 FOR FANS SOLVING MYSTERY

I WON'T BLOOP CLUB MAKING BIG STRIDES

CAMPAIGN TO CLEAR ETHER IS PROVING POPULAR

Listeners, Stations, Clubs and Newspapers Joining Radio Digest to Lessen Radio Interference

"I Won't Bloop" will be the motto of a nation of Radio listeners in short order if the popularity of the I Won't Bloop club continues to grow in the next six weeks as it has in the past three. Broadcasting stations, newspapers, and Radio clubs are taking up the cudgel to exterminate the Viper Bloop.

The idea of the club, as stated previously, is simply to obtain members, the sole requirement for membership being the taking of a pledge to refrain from blooming one's set, or so equip or renew it so as to prevent its blooming. That the idea is a righteous one, is evident from the furor the club is creating.

Thousands upon thousands of pledges already have been made. An accurate count is impossible as yet. The membership roll is, however, several times ten thousand. These members each possess a membership card. Ask your friend to show his card. Get his pledge if he hasn't one.

Opinion Favors Club Idea

That the press and broadcasters have joined hands with Radio Digest in its campaign to eliminate or at least reduce the bothersome blooming evil, speaks well for the timeliness of the great movement.

The broadcasting station chapter roll of the I Won't Bloop club, now includes:

CKNC, Canadian National Carbon Co., Toronto, Ont.; WDAF, Kansas City Star, Kansas City, Mo.; KSL, Radio Service Corp. of Utah, Salt Lake City, Utah; WHO, Bankers Life Co., Des Moines, Ia.; WHA, University of Wisconsin, Madison, Wis.; WLW, Crosley Radio Corp., Cincinnati, Ohio; WJAZ, Zenith Radio Corp., Chicago; WOC, Palmer School of Chiropractic, Davenport, Ia.; KTHS, New Arlington hotel, Hot Springs National Park, Ark.; WBAP, Fort Worth Star-Telegram, Fort Worth, Texas; WMBB, Trianon Ballroom, Chicago; WJJD, Loyal Order of Moose, Mooseheart, Ill.; KQV, Doubleday-Hill Elec. Co., Pittsburgh, Pa.; WAMD, Hotel Radisson, Minneapolis, Minn.; WRK, Doron Bros. Elec. Co., Hamilton, Ohio; WSKC, World's Star Knitting Co., Bay City, Mich.; KFYZ, Hoskins-Meyer, Bismarck, N. D.; WJAG, Norfolk Daily News, Norfolk, Nebr.; KFVC, L. E. Wall, San Bernardino, Calif.; KFKZ, F. M. Henry, Kirksville, Mo.; WBBY, Washington Light Infantry, Charleston, S. C.; WDFD, F. D. Fallain, Flint, Mich.

Cities Organize Local Clubs

Broadcasting stations who are aiding the campaign, or who wish to become chapters of the I Won't Bloop club, are requested to communicate with Radio Digest. The club wishes to enlist every station in the country in its warfare against blooming receivers.

Word has been received from E. M. Rait telling of the formation of a local chapter

Sport Broadcasts

Hockey Game

Tuesday, February 23
WBZ, Boston, Mass. (833.1m-900kc). Boston Bruins-St. Patricks, 8 p. m. Eastern time.

Basketball Games

Saturday, February 20
WSUI, Iowa City, Iowa (483.6m-620kc). Northwestern-Iowa, 7:30 p. m. Central time.

WEAO, Columbus, Ohio (293.9m-1020kc). Michigan-Ohio State, 8 p. m. Eastern time.
WIP, Philadelphia, Pa. (508.2m-590kc). University of Pennsylvania-Cornell, 8:30 p. m. Eastern time.

Monday, February 22

KUOM, Missoula, Mont. (244m-1230kc). University of Washington-University of Montana, (no time given).

Tuesday, February 23

KLDS, Independence, Mo. (441m-680kc). William Jewell college-Westminister college, 7:30 p. m. Central time.

Thursday, February 24

KWSC, Pullman, Wash. (348.6m-860kc). Oregon Agricultural college-Washington State college, 7:30 p. m. Pacific time.

Friday, February 26

KFMQ, Fayetteville, Ark. (299.8m-1000kc). University of Arkansas-Texas Christian university, 7:30 p. m. Central time.

WOI, Ames, Iowa (270m-1110kc) Missouri-Ames, 7:30 p. m. Central time.

LADY STAR OF CHANTICLEER COURT



Jean Grissom is a member of the Chanticleer Players of Kansas City whose series of comedies and specialties from WDAF, the Kansas City Star, is a rather new feature for the station's listeners. The players have grown from a group of persons interested in the theatricals largely for their personal diversion. They now present and broadcast regular monthly programs in a rustic frame building they call "theater," and is really a transformed garage. Their material usually consists of one-act comedies, satires and dramas with musical numbers occasionally interspersed.

of the I Won't Bloop club at Rochester, Minn. One hundred members were enrolled at the first meeting. Other localities are likewise organizing.

The Broadcast Listeners association of Chicago, has promised full cooperation. This organization has already been pioneering in a movement against bloopers.

The various local chapters are, for the most part, discussing ways and means of preventing blooming. Excellent articles are available. At this time the technical staff of Radio Digest is publishing a series

of articles dealing with this subject. The location and suppression by "force or kindness" of vicious bloopers who will not cooperate otherwise is the avowed purpose of one local chapter.

Remember—in all this campaign—that so-called "regenerative" sets are not more to blame than other receivers. So far as can be determined, ALL sets regenerate, and regeneration is more the act of God than a patent.

Have you joined yet? **SIGN AND MAIL THE PLEDGE TODAY.**

PLEDGE CARD

Radio Digest

PROGRAMS Illustrated

I WON'T BLOOP CLUB

Reg. U. S. Pat. Off. & Dom. of Canada

I pledge myself to operate my Radio set to reduce radiation or blooming. If I am unable to make my present set operate properly, I further pledge myself to replace it with a receiver that will create less interference.

Make of my set:

Signature

Number of tubes is:

Address

City and State.....

I am cooperating in this campaign with Station.....
Upon mailing this pledge to Radio Digest, "I Won't Bloop Club" membership card suitable for wallet or framing will be issued.

SPECIAL RADIO SERIAL NEEDS RIGHT ENDING

R. J. Casey Writes Story

First Chapter Next Issue—Important Announcement—Contest to Develop Radio Play

Solve the mystery, if you can, and win part of the \$500.00 in gold, Radio Digest will pay for the best solution!

Beginning next issue, there will appear the first installment of a great, thrilling, inspiring story of love and mystery, written by Robert J. Casey, the world-famous author. He has prepared a story especially for Radio. It is so written that it will go down in history as a pioneering effort of the first order.

Readers of the story will come in for their share by unraveling the tangled plot and pointing out how the story must end. The guilty party or parties should be indicted. All clues should be as correctly followed as possible.

The correctness of the solutions submitted will form the basis for the decision of the judges. Writing ability will not be the main consideration.

Story Begins Next Issue

The first chapter of this supreme work by Robert J. Casey will appear in the February 27 issue of Radio Digest. Other important announcements are also to be made next week.

The full details of the competition, the rules, names of judges, the closing date by which the solutions must be received—all will be told in the next issue of this publication.

Watch for it. Thousands of people are expected to participate in this first All-Radio mystery story competition, and may the best man, or woman, win. Read the first chapter. Don't miss it!

On page eight, this week, the preliminary announcement appears. Emphasis cannot be placed too heavily upon further announcements to be made next issue.

Seventeen Prizes in All

Seventeen prizes await their winners. The first will be \$250 in gold. Second will be \$100 in gold. Fifteen bags of gold containing ten dollars each, will be presented to the persons submitting the next fifteen best solutions to the mystery.

Robert J. Casey, novelist and short story writer of repute, has contracted to write the manuscript. He was directed to prepare a mystery story, replete with thrilling suspense, which was Radio in character. He was told that one of the principal objects of the story was to have it so arranged that it could be dramatized for Radio presentation. The story must have the necessary requisites of a Radario or drama of the air.

Contests Will Develop Radio Play

To foster the development of stories which can be broadcast in Radario form, Radio Digest has launched this new enterprise. It is believed that among the contestants who submit their solutions to the mystery will be found people who have the talents to qualify for further writing of stories designed especially for broadcast presentation.

Mr. Casey's story will show these people how it is done. He not only knows the ordinary school of the novel and stage drama, but is experienced in the limitations of Radio and knows what the broadcast drama needs as a means of expression.

Just as the legitimate stage and motion pictures use thousands of stories each year, the majority of which are especially prepared either for the stage or the screen, broadcasting stations are now looking for available manuscripts for Radario presentations. The number of writers supplying this market is small. The field for Radarios, too, is still small but is potentially great.

It is the hope of this publication to enlarge both the field for, and the number of writers of Radarios.

New Studio for Boston

BOSTON.—Houghton & Dutton, one of the largest department stores in New England, have announced that they are to open a broadcasting studio the latter part of February in their store, co-operating with WEEL, the Edison station here.

Uncle Sam Aids Rural Radio

"Fifty Farm Flashes" to Be Subject of Weekly Broadcast Under Auspices of Department of Agriculture

By S. R. WINTERS

FARMER JONES upon observing that his flock of chickens has symptoms of roup addresses a letter to the United States Department of Agriculture in search of a treatment! Farmer Brown inquires of Uncle Sam as to what months should cows freshen in order to insure a maximum production of milk! Farmer Smith upon detecting that his soil is sour, wants to know if a portable lime crusher is practical!

These inquiries, when received by the United States Department of Agriculture, are answered by letter mail in which a farmer's bulletin discussing the particular farm problem is enclosed. Now, farmers will not have to depend upon a tardy R. F. D. service for such general and insistent information where timeliness is an important factor. Instead, Radio, traveling with the speed of light or at a rate of 186,300 miles per second, will act as a hurry-up messenger between farmers and Uncle Sam's national farming bureau.

Sam Pickard, newly appointed Chief of Radio Service of the United States Department of Agriculture, has labelled this novel and informative service with the alliterative and pleasing designation, "Fifty Farm Flashes." As implied by this descriptive phrase, brevity and speed of delivery will characterize this service and if a sufficient number of broadcasting stations are enlisted in diffusing this timely and useful knowledge it will be blanketed over the agricultural areas of the nation. Each "Farm Flash" will be limited to fifty words and the broadcasting of the complete weekly service should not exceed twenty minutes.



PICKARD
Will Operate Through Washington Bureau to Answer Important Inquiries from Farmers over the Representative Stations in Scattered Districts. Will Cooperate with State Colleges.



Sam Pickard (top) with one day's letters from farmers to U. S. Department of Agriculture. Tom Peterson, Kansas farmer, making notes on answer to letter through Radio. C. V. Cochran, another Kansas farmer who finds Radio practical.

THE Department of Agriculture in Washington, receives approximately 4,000 letters daily, a major portion of which concerns farm problems or direct questions seeking solutions to the difficult things confronting the farmers. From this "question box" will be selected each week about twenty-five of the more general and pressing subjects or problems as a basis for the "Farm Flashes"—or, to employ the term of Mr. Pickard, Uncle Sam's mail will serve as a sort of barometer in the preparation of this national Radio service. The other twenty-five topics included in the "Fifty Farm Flashes" will be of a local nature—that is, solutions to problems peculiar to a particular farming community, which is served by a certain broadcasting station. Thus, Uncle Sam's farm Radio service will not be a rubber-stamp or mimeographed affair but an exclusive feature to the respective broadcasting stations cooperating in this significant and far-reaching step in annihilating distance between the rural areas and the fountain sources of scientific agricultural information.

Tentative plans of Mr. Pickard call for a division of agricultural America roughly into zones with respect to the major crops grown in the different farming regions. These classifications will include such dominant crops as cotton, corn and meat, hay and pasture, and such types of farming as dry land, range,

and irrigation. Thus, for instance, a farmer making inquiry about methods of producing corn would receive a reply in the form of a "Farm Flash"—say, through a Chicago broadcasting station—that would be applicable throughout the Corn Belt. Similarly, a cotton grower of Texas, seeking information as to an effective method for combatting the boll weevil would elicit a reply—broadcast through a Texas station—of value to the cotton producers of the South and Southwest. Or, to continue this trend of thought, wheat growers in Kansas could, through the magic of the invisible Radio waves, learn of the most effective method for arresting the fecundity of grasshoppers.

* * *

THIS Radio service to farmers will be a radical departure from the present practice of preparing lectures and having them read into the microphone," declared Mr. Pickard, in an exclusive interview given this writer, in which he stressed the twofold factor of brevity and popular appeal in the presentation of "Fifty Farm Flashes." Moreover, the Chief of Uncle Sam's Farm Radio Service desires to avoid the erroneous impression that the United States Department of Agriculture will dominate this instantaneous and sweeping means of disseminating information relating to better farm practices. To the contrary, the agricultural colleges and other agencies cooperating will be tapped as sources for much of the material that is to be broadcast, the Department of Agriculture at Washington, serving as a clearing house or central agency for supplying any needed information which may not be accessible to state and local agencies. Then, too, Uncle Sam has his own representatives afield and their services will be constantly in demand in making effectual this far-reaching program of speeding up the process whereby the searchers of information and the source may be brought together within the twinkling of an eye.

"Fifty Farm Flashes," an alluring phrase that will live because it is dedicated to service, will be inaugurated as a weekly program from hundreds of broadcasting stations—if the latter are quick to appraise its popularity and value. The air mail and other prompt postal facilities will speed the delivery of these "Farm Flashes" to the respective broadcasting stations, scattered as they are in widely separated sections of the country, assuring prompt answers to inquiries. (Continued on page 29)

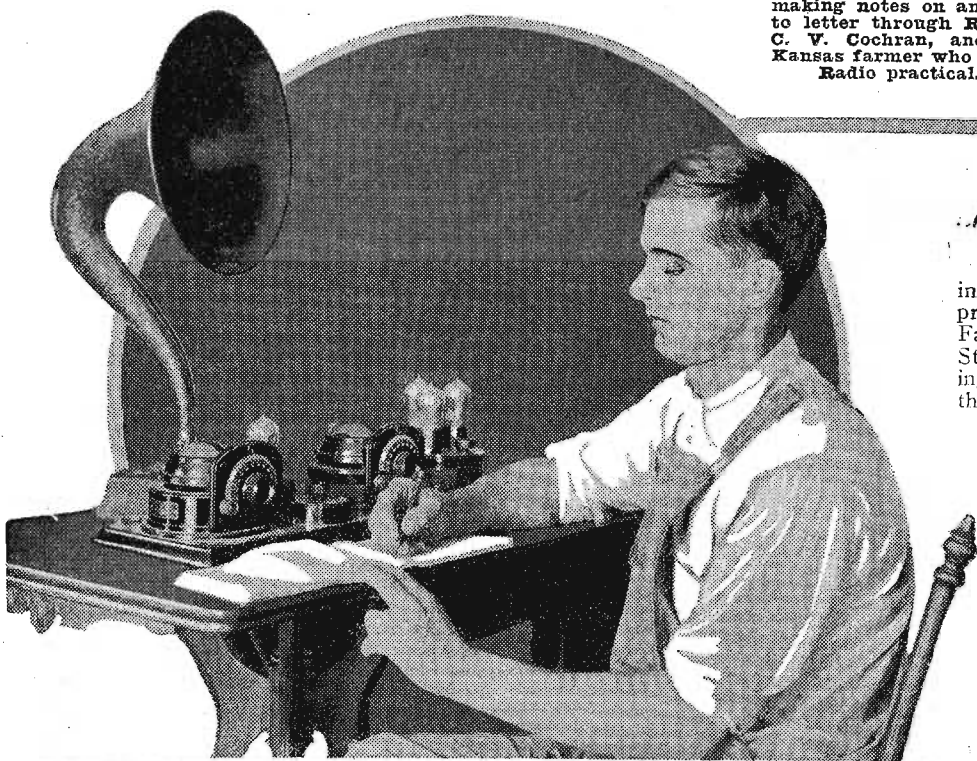

Let's Go! WJAG Throws a Party!

ALL Listeners Are Invited to Attend Big Celebration Around "Family" Table in Norfolk, Nebraska. "Printer's Devil" to Be There.

MR AND MRS. G. R. SALTER cordially invite you to be present at the Fourth Anniversary of the Norfolk, Nebraska, WJAG Family Lunch Club during the Noon Hour of February Twentieth, Nineteen Hundred and Twenty-six, at your own Receiving Set."

Of course you will have a lovely time at Mr. and Mrs. Salter's party. They are counting on a very unusual number of guests from all parts of the country. It will be one of the big events of their lives and that covers a very considerable period. Both are over 86 years old. They have been married sixty-four years. Since the Norfolk Daily News installed its Radio broadcasting station and Announcer Karl Stefan organized the Family Lunch club Mr. and Mrs. Salter have been sitting at the "head of the table" as the grand patriarchs of the family, which consists of 20,000 persons.

Forecasts of proposed offerings are "flashed" to members of the family for approval. The mail man and the messenger boys and the telephone bring to the studio the answer as to what shall be used and what not used. Now Grandfather Salter believes he knows just what his family wants for this big birthday dinner of February 20.

NEBRASKA stands out among the pioneer states in the Radio world. Several broadcasting stations became famous within its borders while Radio was still quite young as a general amusement. Gene Huse, editor and publisher of the Norfolk Daily News, was among the first to put in his order for a station and then discovered that he didn't have, and there was small chance of getting, an operator.

Determined to have his station even if he had to become an expert himself, he began a study of Radio transmission. He learned the codes, both Morse and Continental. He mastered a thorough knowledge of the technical theory and finally came to Chicago for his examination. He successfully passed the test submitted by Inspector Beane and was granted an operator's license. He is one of the few owner-operators of a broadcasting station in the United States.

Mr. Stefan was on the staff of the News when WJAG went on the air. He had been around the world, could speak several languages, understood telegraphy and Radio technique. It was logical that he should become the chief announcer and this position he has held since the beginning.

Station WJAG was launched as an avenue of service by the Daily News which has for its slogan, "World's Greatest Country Daily Newspaper." Old people, invalids and other shut-ins soon discovered that "service" was more than a catch-word. They were the first to feel the results, which came shortly after the end of the World's Series baseball games.

THERE was a particularly keen interest in the series that year and Announcer Stefan moved the microphone from the "Printer's Devil's Den" (as the studio is called) to the telegraph desk where the



Karl Stefan (top) chief announcer at WJAG who started the big "family" that gathers around Radio lunch table each noon. Frances Colton Warner (left), pianist and entertainer.



Old-fashioned melodies are the favorite songs of Miss Marjorie Beeler (left), lyric soprano at WJAG. Below may be seen the Printer's Devil and his Imps. They ring the dinner bell that calls everybody around the big family Radio lunch table presided over by the patriarchs, Mr. and Mrs. G. B. Salter, both 86 years old. At lower left is staff of the Norfolk Daily News translating the telegraph code of a world's series game into a word picture for WJAG listeners.



clicks of the telegraph instrument were instantly translated by Mr. Stefan into word pictures of the game. An appeal was then sent out to members of the Radio family for nickels and pennies with which to buy receiving sets for the shut-ins who never could participate or even see athletic games of any sort.

Contributions rolled in to such an extent that there was soon enough money to buy a dozen good sets for those who could not afford them and were confined to the dull monotony of the four walls of their rooms. The first one went to a little crippled girl for whom the initial appeal was made, little expecting there would be enough returns for a dozen sets.

As the family grew from a score to 20,000 other appeals have been sent out at intervals until now there are 100 sets bringing cheer and happiness. Sometimes the sets change hands where the original beneficiary has recovered and is no longer an invalid. Six sets have been returned from those who have passed beyond the pale of early joys. Then the service of WJAG was

(Continued on page 24)



KMA Is Heard Across Pacific

“KEEPS Millions Advised” Is Slogan Selected from 4,000 Suggested for Shenandoah, Ia., Station. Listeners Write from Yokohama, Australia and Alaska.

By H. P. BROWN



At left is Miss Ormah Carmean, soloist and associate program director, KMA. Below are Mrs. E. E. May (left) and Mrs. Henry Read, duet singers. George Van Houtte (lower circle), 79, traveler and lecturer. Beside him, Lina Ferguson, “May Flower Lady,” who chats of gardens.

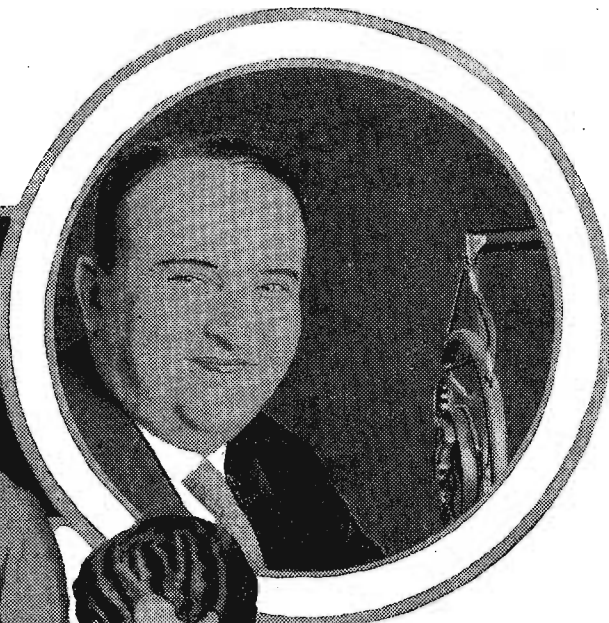

Above is Mr. Earl E. May, himself, owner of the KMA broadcasting station at Shenandoah, Ia., who usually mans the microphone to introduce the artists. His “contagious laugh” ripples through the ether making thousands smile.

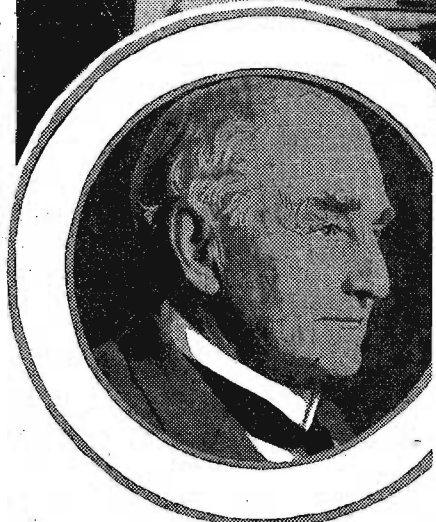

LOOK at the Radio map of the United States and you will find the state of Iowa thickly dotted with little red stars where broadcasting stations are located.

In the galleries of the air, Iowa's calls may be heard at almost any hour of the day or night. The entire populace seems to be swept off its feet with Radio enthusiasm. No farm is complete without its receiving set. In some places the loud speakers are installed in the barns where the “cornhuskers” can hear while milking the cows and there is a theory that the music smooths the cows into yielding, not only more, but better milk.

Shenandoah, close to the Missouri border, was comparatively little known a few years ago. Two of the main industries of the town are seed and nursery companies. Both of them installed Radio broadcasting stations and the Shenandoah post office had to put on a night shift to handle the extra mail that resulted.

Earl E. May, president of the May Seed and Nursery company, at Shenandoah, is the rotund, good natured papa of KMA. When one talks to him a little while it is hard to tell which he loves the most, the seed business or Radio.

* * *

PART of the time he is all tomatoes and radishes and the rest of the time he is all studio and listeners. So much enthusiasm backed by a vigorous constitution and an artistic appreciation has produced the inevitable success it deserves with both enterprises.

“Why,” said Mr. May in the course of a recent interview, “we have the most wonderful talks on horticulture, agriculture and gardening and when we put on a contest for a slogan a short time ago, we received 4,000 letters offering suggestions. We picked fourteen quarts of the most luscious—I mean we picked a slogan that I think fits our station to a T.”

“K-M-A—it couldn't have been ‘Kiss Me Again?’”

“Don't be absurd. This is really serious.”

“Well, what could it be? Knights of Modern Agriculture?”

“More foolishness. Here it is—“KEEPS MILLIONS ADVISED.”

“That's not so bad only—”

“Only what?”

“Well, ‘millions’ might seem a little exaggerated.”

“Exaggerated nothing! Wait 'till I show you a letter, here.”

Mr. May fished a letter out of his pocket. At the top was the business head, “N. D. Sheppard, General Merchandise and Raw Furs, Andreafsky, Alaska, Oct. 31, 1925.” The letter read in part as follows:

* * *

“I WISH to report that we heard your station the night of October 30, you signing off 10:12 p. m. our time, which was 3:12 a. m. October 31, your time. The program came in fine just as clear as a bell in spite of the fact that one of the tubes was broken so the built-in loud speaker would not work and we had to attach the ear phones to the talking machine. We all enjoyed the program which was plenty loud in a room seventeen by twenty-seven feet.

“At 11 p. m., our time, we picked you up again and heard the Midnight waltz and Three O'Clock in the Morning, on the Steinway. This program we enjoyed until 2:15 a. m. our time, when it faded away so we do not know just what time you signed off.

“We are two weeks from a cable office by dog team or we would have sent a cable. We are 163 degrees west and 62 degrees north on the Yukon river.”

The letter was signed by N. D. Sheppard.

“Don't worry about the ‘millions’ part of it,” added Mr. May, as he folded the letter back in its envelope. “KMA is not only heard all over the United States with its many millions of Radio listeners, but we have letters from Australia, Yokohama, Japan; the Hawaiian Islands and other places to the north and south. Don't ever think that ‘millions’ is exaggerated.”

It was stated that the KMA station prepared its programs with enough diversity to please all classes of listeners. Reports on the weather and markets are given three times (Continued on page 24)



These four (left) should be called the “Apple-o-Quartet.” They are Jonathan and Ben Davis, Auntie Blossom (Mrs. Fort, who conducts the Slumber Boat) and Miss Lavone Hamilton, pianist, the Pippin.

WKAQ—"Voice of Porto Rico"

ISLAND Territory in Antilles Entertains Listeners on Both Sides of Atlantic. Announcer Is Spokesman for the Isle.

AS THE Florida stampede grows and it begins to look as though the swarms of tropical tourists are going to be crowded off the edges of the peninsula into the ocean, it is possible part of the traffic stream may detour to Porto Rico—"The Island of Enchantment."

Here the snow dodgers should find complete happiness for it NEVER, NEVER snows in Porto Rico. The average daily temperature is 80 degrees. The island is 100 miles long and 36 miles wide and was ceded to the United States by Spain after the Spanish-American war. There are over a million inhabitants on the island and all loyal Americans, adopted by act of congress in 1917. Each year has found a

new increase of visitors and permanent inhabitants from the States. The country is verdant and hilly; the highest peak is over 3,600 feet.

Along the coast are crystal clear lagoons. Coral reefs bend into the sea and there are plentiful sandy beaches. San Juan, the capital and metropolis, is quite modern—a fact acknowledged by Radio listeners on both sides of the Atlantic for programs broadcast from WKAQ have been heard in Spain as well as on both American continents.

"Whose is the voice with the Spanish accent?" has been a frequent query of American fans after listening to WKAQ, an American call signal. The voice is the author of the following story, Joaquin Agusty.

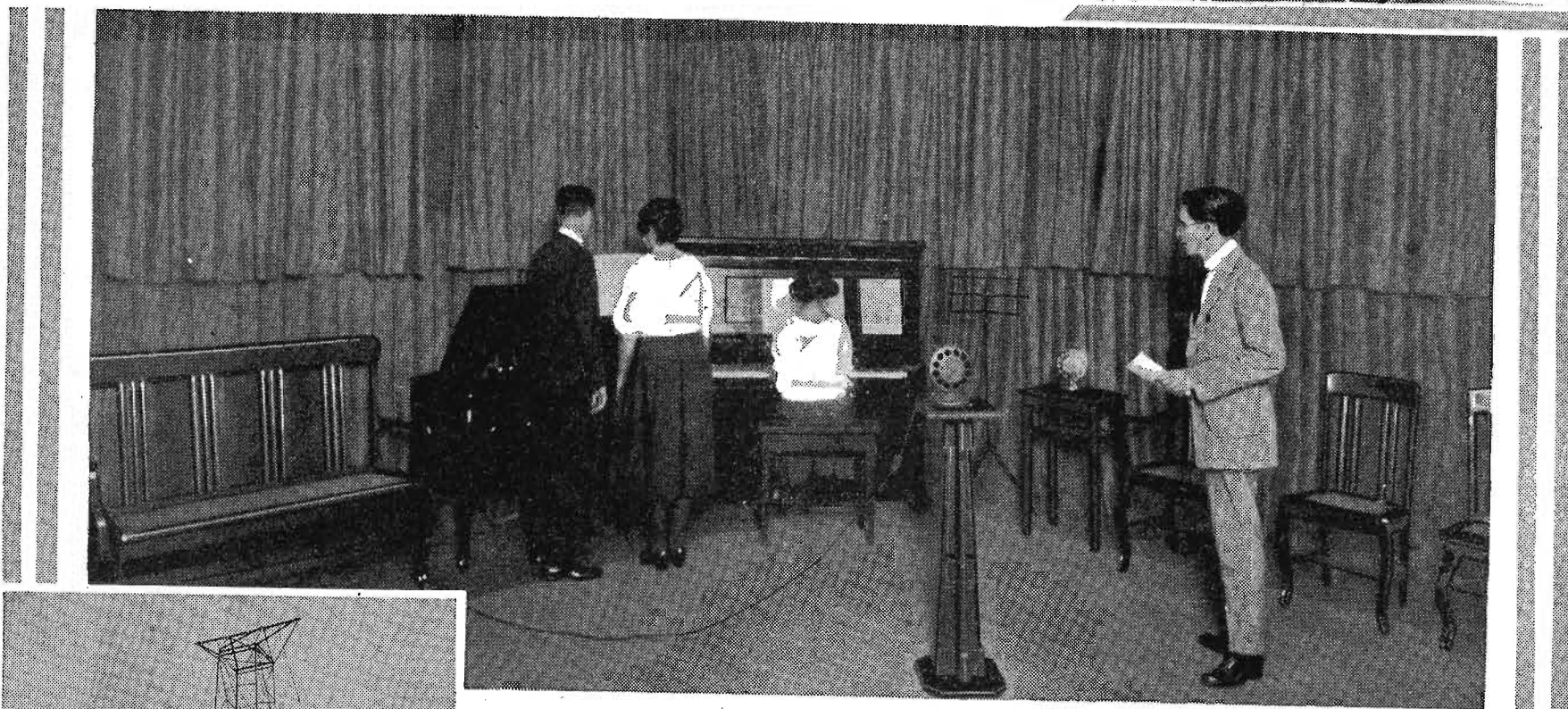

At the top is Joaquin Agusty, announcer at WKAQ, San Juan, Porto Rico, the "announcer with the Spanish accent." Mr. Agusty is a young Radio enthusiast and takes his responsibilities in the Radio world with proper seriousness. He writes that he feels his voice is the voice of Porto Rico itself and he tries to make it the most friendly voice of all. Above is a scene in the WKAQ studio during an evening's program. Below is the antenna of the WKAQ station.

By JOAQUIN AGUSTY

SINCE December, 1922, the voice of WKAQ has been heard through the crowded ether by the Radio fans of the world.

It is a powerful voice, quite different from the more delicate tones that come from those familiar friends, KDKA, WGY, WGN, KGO and their sister stations in the United States. But of all the voices speaking it tries to be the friendliest and most cordial because it is the voice of Porto Rico, itself, "The Island of Enchantment," speaking for a people, a country surrounded by a boundless ocean.

And not only is WKAQ speaking to its own island but it is sending the voice of Porto Rico to make friends in hundreds of cities and lonely farm houses in America, Cuba, England and Spain.

It is as though our beautiful island were suddenly made personal and articulate and endowed with a voice capable of disregarding the handicap of distances of oceans.

What do you know about Porto Rico and its broadcasting station? It will be of particular interest to the real Radio enthusiast to describe somewhat in detail this WKAQ which, in a sense, belongs to us all. Especially is it of interest to citizens of the United States for over our microphone floats the Stars and Stripes at its most eastern outpost.

WKAQ is the Radiophone station of the Radio Corporation of Porto Rico, affiliated with the International Telephone and Telegraph corporation of 41 Broad Street, New York. It is installed in the top floor of the Telephone building, in the center of the city of San Juan, and its geographical position is Lat. North 18°, 25', 4", Long. West 66°, 6', 57". The station occupies four rooms. The transmitter is the standard Western Electric 500-watt output.

Actual radiation on 834 kilocycles is 6¾ amperes. The antenna is 3 wires 90' long with 4' separation between them. Two Milliken steel towers, one 167' high and the other 87' on top of the Telephone building, support the antenna, the direction of which is north-south.

The studio walls are covered with a layer of blanket material under curtains to deaden echo, and the floor is heavily carpeted. After some experiments it was found that the ceiling did not require covering. The studio is furnished in contrasting tints of blue.

The reception room is right under the steel tower on top of the building. Artists wait here for their turns at the microphone.

The Radio room is the place for the operator, Mr. E. Camunas and contains all the apparatus except the motor generator and batteries. The power room is in one corner of the building and well separated from the studio. This permits good working conditions without noises.

(Continued on page 24)

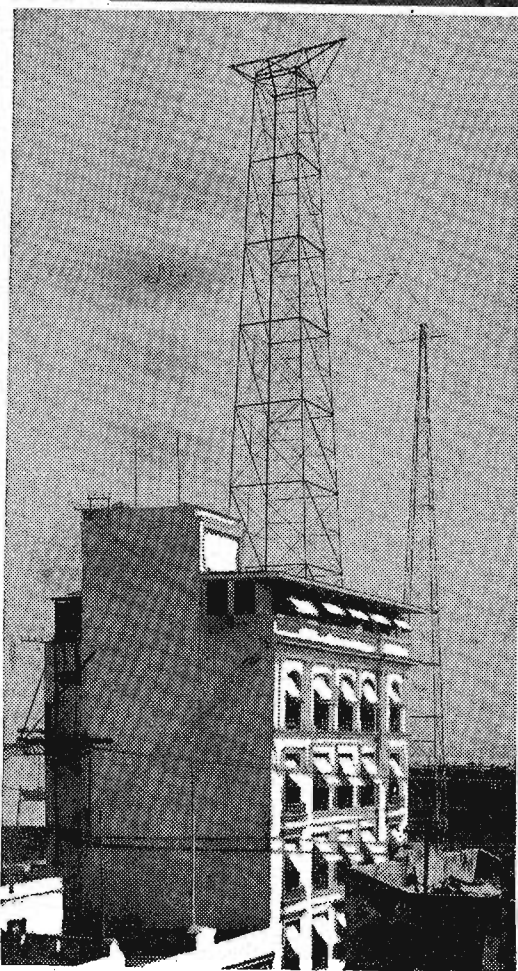

Radio Mystery

**In Bags
of Gold**

\$500⁰⁰

**In Cash
Prizes**

Will Be Awarded for the Best Solutions

Mystery - Adventure - Murder - Love

*The Thrill of Intense Suspense. The Surging
Flow of Life's Emotions. Uncanny
Cleverness. Overwhelm-
ing Love.*

Radio Digest
PROGRAMS
Illustrated
REG. U. S. PAT. OFF. & DOM. OF CAN.

First Radio Serial Competition in which all will have an
opportunity to win fame, honor and

Bags of Gold!



Robert J. Casey

THE Story is by Robert J. Casey, world famed author of "Brothers of the Gun," "Long Arm of Andy Irons," "Vest Pocket Anthology," and over two hundred creepy, mystery stories. He is easily the peer of climax builders; the master mind of imaginative intrigue; the apex of creators of thrilling episodes and unforgettable complexities.

In this story, written especially for Radio Digest, Mr. Casey has risen to new heights in creative fiction. The lust of Gold—unwavering Love—and the mimicry of make-believe, are each pictured in a dialogue and action that will hold you spellbound to the end.

Complete Details of this Amazing Contest Will Appear Next Week

MARCONI ERECTS BIG BEAM STATION

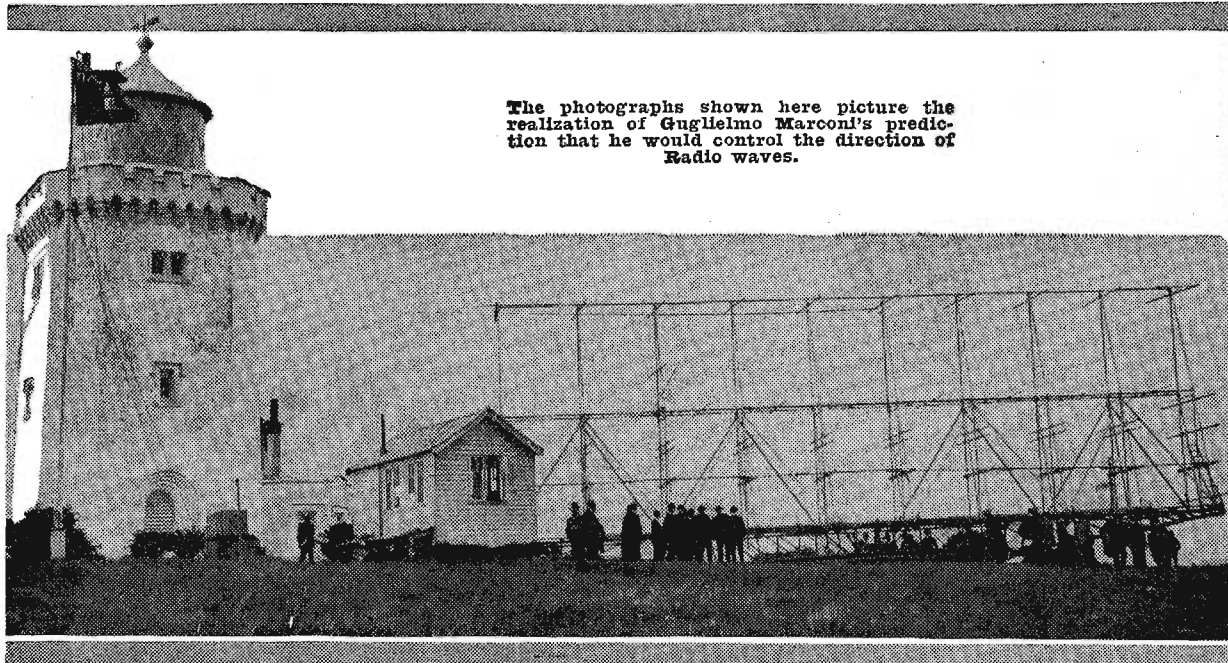

The photographs shown here picture the realization of Guglielmo Marconi's prediction that he would control the direction of Radio waves.



SEARCHLIGHT BEAM Radio transmission was announced several years ago by Marconi to the surprise of everyone interested in Radio and its future. Before that time it was thought that Radio waves would never be controlled. Guglielmo Marconi, who first made wireless telegraph possible, after years of further research told the public that he could direct Radio waves in whatever direction he wished, and that listeners living in other directions would be unable to receive his waves.

Here is his answer to the practicability of his "searchlight beam" Radio invention. In England at the South Foreland lighthouse, he has erected and installed a high-powered beam transmitter and rotating uni-directional antenna.

Besides adding to the secrecy of Radio messages, Mr. Marconi's invention is said to permit a saving of power and dissipated energy. Using much less power than is ordinarily used by transatlantic stations, his beam transmitter at South Foreland has been heard in Australia, equally as strong as the high-power stations.

SIX WIN PRIZES FOR FOREIGN DX REPORT

RADIO DIGEST ANNOUNCES TEST WEEK WINNERS

Iowa Physician Takes \$50 First Award for Twenty Overseas Broadcasters—New Yorker Second

Winners of the six prizes, totaling one hundred dollars, offered by Radio Digest for proofs of best reception of foreign stations during the International Radio Week tests are:

First, \$50, Dr. J. D. Hullinger, 108 The Weston, Clinton, Iowa. Dr. Hullinger received twenty foreign stations during the first five nights of the tests, exclusive of Mexico. Of the twenty, fourteen were different. His receiver was a nine tube super-heterodyne, home built, coupled to an outside aerial.

Second, \$25, Harry Leadbetter, 208 West 103rd street, New York city. Mr. Leadbetter received fourteen different foreign stations, eight of which were different. Mexico was not included. His receiver was a five tube manufactured radio frequency set.

Third, \$10, H. Livingston, West Plains, Mo. Although some of the other prize winners received more stations than Mr. Livingston, his distance west of Europe was considered as a handicap. He picked up, exclusive of Mexico, eight foreign stations during four out of the first five nights. Five of these were different. His set was an eight tube super-heterodyne of the four filter type, similar to one described a year ago in these columns.

Fourth, \$5, James L. Snyder, Patton, Cambria County, Pa. Mr. Snyder received nine different foreign stations, one of which was only partly verified. Six different foreign stations were among the nine. His set was a manufactured five tube radio frequency receiver.

Fifth, \$5, Paul H. Davis, of Chicago, whose receiving post was located at the hunting lodge of Joseph Crum, on the broadwaters near Oyster, Va. In but two nights, Mr. Davis succeeded in bringing in seven different foreign broadcasters. Fourteen stations in all were heard, but confirmable proof was submitted for but seven. His receiver was a manufactured six tube portable radio frequency set.

Sixth, \$5, Master Sergeant Louis Hahn, of the 212th coast artillery, 120 West Sixty-second street, New York city. Sergeant Hahn, who submitted his report

260 DIFFERENT KINDS OF SETS HEAR KFNF

SHENANDOAH, Iowa.—Are you planning to buy a new receiving set? Then you'll be interested to learn that KFNF, Henry Field station here, has 260 different makes of sets represented in its audience.

Buy your pick after looking over the few.

The figure was obtained recently when an old-time fiddling contest was broadcast. Thirteen aged fiddlers participated. The listeners were to pick the best of the thirteen, the only condition being that in mailing one's vote the listener must mention the manufacture of his or her receiver.

The total number of votes cast was 23,343, and among the number a variety of 260 different makes of sets picked up the program.

with unusual military neatness, did not do so well as many other contenders who were less careful, but his record was above the ordinary. He received five foreign stations, four of which were different.

According to the many letters from listeners who entered the International reception contest, over 200 clergymen, many lawyers, doctors and teachers, and a great many women attempted to win the prizes offered. The women's reports were invariably complete with detail. They did not overlook description of what they heard.

However, men still seem to rank as best dial manipulators, so far as DX is concerned. A growing interest on the part of the weaker sex is noted, regardless of its absence of the prize winning list.

Every state in the Union was heard from, but the western states, on the whole, received but few of the European or South American broadcasters. Mexico, most provinces in Canada, and the Bermudas also entered the tilt.

Why Many Contestants Failed

Many excellent reports of reception were passed aside by the judges because some requirement was not met. Some omitted to describe the equipment used. Others were illegible. Still other reports were miserably organized and difficult to check.

It is surprising to note the illegibility of many adults. All of the many thousands of reports of reception were replied to by the International Tests department of Radio Digest, and Confirmation Certificates—if earned—were mailed to fortunate fans, except in cases where legibility was so poor as to prevent proper addressing. Some listeners evidently received extra-

Legion Notes

The Iowa department of the American Legion will broadcast its official program Tuesday evening, February 23, 7:30 to 9:00 p. m. Central time, over Station WHO (526m-570kc). Addresses will be made by National Commander John R. McQuigg; Hanford MacNider, assistant secretary of war and past commander of the Legion; National Adjutant James F. Barton and Governor John Hammill.

A musical program and addresses by the department officers will be broadcast by the Wyoming department of the American Legion over Station KFBU, Laramie, Wyo., (270m-1110kc), Friday, February 26, 9:00 to 11:00 p. m. Mountain time.

The Wisconsin department of the American Legion will broadcast its 1926 barrage, February 22, from Station WKAF, Kesselman-O'Driscoll, Hotel Antlers, Milwaukee, Wis. The program will run from 8:00 p. m. until 2 a. m. Central time, with the exception of an hour between 11 and 12 o'clock.

Station Gives Program for Staunch Listener in Alaska

BUFFALO, N. Y.—WMAK, with studio here, has been heard repeatedly during the last few months by a man who signs himself S. Sheldon, at Haines, Alaska. Buffalo is his native city and he has been so enthusiastic about the WMAK programs that "Al" Erisman, manager of WMAK, put on a complimentary program for S. Sheldon after midnight recently. Among the great variety of musical and other numbers was one in which Walter T. Sheldon, a brother, participated. A telegram of greeting from the father of the brothers who lives in Ohio, was also read for it was the father's birthday.

ordinary well, but did not give sufficient key information to allow checking for confirmation.

Dr. Horace B. Fenton, of Portland, Ore., deserves at least honorable mention. It is therefore awarded to this Westerner for his fourteen-page report, and his constructive criticisms so carefully made. Several hundreds of others contestants, too many by far to list here, are also deserving of honorable mention, but space forbids.

One error in the confirmation programs, published last issue in Radio Digest, must be noted. The wave length of HA, Hamburg was listed as 292.5 meters. The figure should have been 392.5.

ZENITH CASE SHOWS NEED OF RADIO LAW

PRESENT SYSTEM UNABLE TO REGULATE ETHER

Acting Secretary Davis Visits Chicago to Discuss Controversy with Radio Supervisor

WASHINGTON.—The urgent need for legislation which would give the secretary of commerce authority to regulate Radio has been stressed by the failure of the district attorney at Chicago to take immediate action against E. F. McDonald, Jr., president of the Zenith Radio Corp., owners of WJAZ. This is the opinion of Senator C. C. Dill and Representative Wallace White, Jr., authors of Radio bills in their respective branches of congress.

In the absence of definite action on the part of the Chicago district attorney against Mr. McDonald for broadcasting on a wave length which he was not authorized to use, officials of the department of commerce refuse to comment on the case.

Davis Visits Chicago

Acting Secretary of Commerce Stephen Davis recently kept a speaking engagement in the Middle West. While there Judge Davis stopped off in Chicago to confer with the district attorney and the local Radio supervisor regarding the case.

Judge Davis refused to disclose his plans before leaving, but it is believed he intends to point out that in his opinion the present law provides sufficient authority for legal action against Mr. McDonald.

Progress of Legislation

There has been no definite action in congress on Radio legislation since the public hearings in the house merchant marine and fisheries committee were concluded. An executive meeting was held in the house regarding the final form the bill should take. Mr. White expects the bill will be reported to the house substantially as drafted before this issue reaches its subscribers.

Indications are that further hearings in the senate on Radio legislation may be deferred until the White bill passes the house.

Receiving sets are to be distributed by a British missionary to natives in the South Sea Islands. Coconut palms, 80 to 90 feet high, are to be used for aerial masts.

New and better Uses No tube

Ends "B" battery
troubles

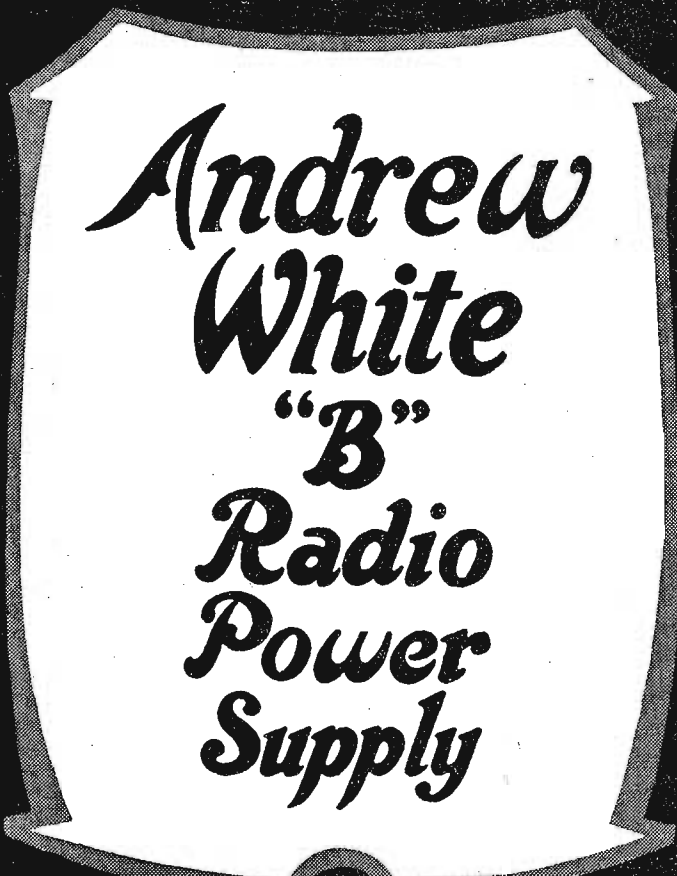

for Alternating Current only
110 Volts 60 Cycle

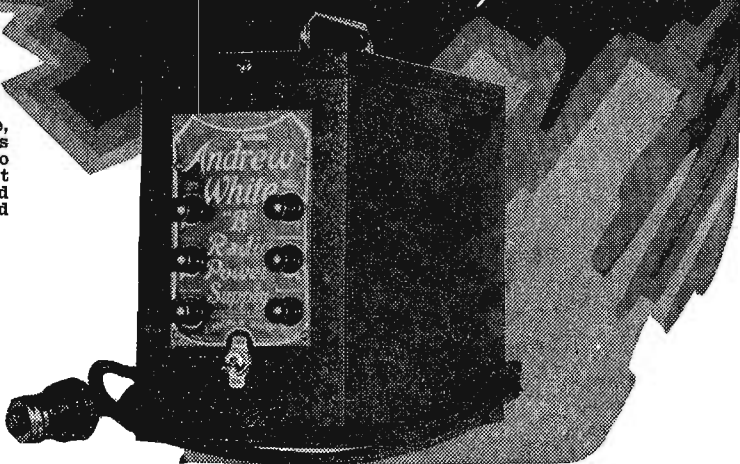

After 15 years in radio I offer this power supply device as the best that can be produced. It has had the most rigorous laboratory tests and months of hard usage under difficult working conditions. I look upon it as a complete solution of the nuisance of replacing "B" batteries in your radio set.

J. Andrew White

Major J. Andrew White, America's famous sports broadcaster, pioneer radio editor, the country's first broadcast director and veteran radio dealer and manufacturer.

Shipped on a satisfaction or money-back basis on receipt of price in money order or currency.

Ready for use at all times, 135 volts of "B" battery current, all you need, now or in the future. It delivers steady supply, operating perfectly at all times all sets using up to 9 tubes. The new tubes and modern sets require 135 volts—don't buy less!

No Hum There is no hum. No noise at all. The current is delivered from EIGHT electrolytic cells. NO TUBES TO FLUCTUATE OR TO REPLACE.

Economical Takes so little current you will notice no difference on your electric light bill.

Durable Will deliver the full voltages you require for detector, radio frequency and amplifier tubes, strong and steady year after year, just as if you had brand new batteries all the time.

Convenient Plugs into electric light socket—nothing to get out of order at any time.

Improves Broadcast Reception

Large size condensers and steady current supply improve the performance of your radio set. You will have better quality of speech and music and greater volume.

No Parts Requiring Replacement or Renewal

A few territories now open for established dealers.

J. ANDREW WHITE, 37 West 43rd Street, New York

**135
Volts!!
Only
\$38**

There is a great demand

Your dealer may not be able to supply you

MAIL THIS COUPON TODAY

J. Andrew White, 37 West 43rd Street, New York.

Enclosed is \$38, for which ship me your new and better "B" Radio Power Supply at once, my money to be refunded if I am not satisfied and return the unit in 10 days.

Name

Street, RFD or Box No.....

Shipping Point.....

Post Office.....State.....

AN EVENING AT HOME WITH THE LISTENER IN IN EASTERN TIME

Table listing radio stations by location and time slot. Columns include Call, Location, Mot., Saturday, Sunday, Monday, Tuesday, Wednesday, Thursday, Friday.

Table listing radio stations by location and time slot. Columns include Call, Location, Met., Saturday, Sunday, Monday, Tuesday, Wednesday, Thursday, Friday.

STATIONS IN ORDER OF WAVE LENGTHS

Table listing radio stations in order of wave lengths. Columns include Meters, Call, Meters, Call, Meters, Call, Meters, Call, Meters, Call, Meters, Call, Meters, Call.

HOW TO PREPARE MEAT (Continued from page 11)

When we cut a piece of meat we cut across the fiber, leaving the ends open so that the juice can run out. That is why we sear the meat the first thing when cooking.

Save Valuable Meat Juices. By searing we mean cooking over the outside of the meat very quickly so that the cut ends of the little fibers are sealed tight, preventing the loss of any more of the juices.

It is because the flavor of the meat is found in these juices that we are so careful to retain them. The meat juices stimulate the production of the digestive juices in the stomach and thus stimulate the appetite. That is why clear soup is served at the first course for dinner and is also why beef broth is given to invalids and convalescents.

Meat is largely protein and protein must be cooked at a low temperature. If it is cooked quickly or at a high temperature, it becomes tough and leathery. For that reason the directions for cooking meat always read "sear it very quickly at first and then cook it slowly for as long as is necessary to complete the cooking."

Cooking Tougher Meats; Pot Roast. Tender cuts of meat, such as roast and steak, may be baked or broiled, but the tougher cuts should be cooked for a long time, very slowly, and in moist heat, that is, with some water. It would never do to cook a pot roast or a stew in a dry oven as we do a roast, or on a broiler as we do a steak.

Moisture and the long slow cooking are absolutely necessary to make the meat tender and palatable. For a pot roast we use a tougher cut of meat than that selected for the oven roast. Sometimes the bottom of the round is used or the chuck or the neck. Here is the kitchen tested recipe for pot roast:

Four pounds of chuck, 2 tablespoons of flour, 4 tablespoons of dripping, 3 teaspoons of salt, and 1 quart of cold water. Method: Wipe the meat with a cloth wrung out of cold water. Rub over the surface with flour. Sear on all sides in the hot drippings until brown. Season with salt. Add water and cook SLOWLY until tender. (About 2 1/2 hours).

Never wash meat in water, as that will dissolve out some of the precious juices. The searing of the meat in the hot fat not only helps to keep in the juices, but also caramelizes the surface of the meat, giving us a good brown color and a rich flavor. For searing, heat the fat in an iron pot or in a kettle in which the roast is to be cooked. Otherwise much of the good flavor will be lost.

Helpful Hints for Pot Roast. Any kind of meat drippings may be used, suet or bacon fat or fat from the meat itself. Be sure to sear it well on all sides. You will notice that the salt is not added until after the meat is seared. That is also to help retain the juices. If it is necessary to add more water during cooking, add boiling water, as cold water would retard the cooking. Let me add once more—cook the pot roast SLOWLY. A good sauce may be made by pouring a can of tomatoes over the roast for the last hour of cooking.

After the pot roast is done, remove it from the pan and add more water to the liquid in the pan. Then make a thin paste of flour and cold water, using the proportion of 2 tablespoons of flour to each cup of liquid, and equal proportions of flour and fat. Pour the paste into the

hot liquid and stir constantly. Add salt to taste, and cook slowly 10 minutes. In many cases gravy is not cooked long enough to cook the starch in the flour, the result being a raw, starchy taste.

For serving, the pot roast may be garnished with vegetables. For example, arrange carrots cut lengthwise to make a border around the platter, or place the pot roast in the center of the platter with the potatoes at one end and some other vegetable opposite.

SHORT WAVES

By Marcella (Continued from page 11)

does he do when he isn't playing the organ? Well, then he teaches organ playing for the Barton organ school.

"Old Timer" is Sen Kaney, "Mike," Gladys and Ina. He's married to a very jealous wife. Watch out. He's about thirty-two years old. Bobby Brown, another KYW favorite, whose Overseas Uke is legend, is married. His age, twenty-eight. Lee Sims, who tickles the Steinway at KYW's Congress hotel studio, is likewise a benedict and about thirty-four years young. Evidently this trio's "Gloom Chasing Hour" is drawing the ladies to the receivers. Sure, they're on every Tuesday, Thursday and Saturday afternoon.

"Helen" thinks she has one on me. Read what she says—all of it:

"Noted in your paragraph about E. L. Tyson of the Detroit News that you did not say YOU danced WITH him at the cabaret. I'll fager five cents worth of applause you carry a MISTER before your name. Be careful or I'll be asking for YOUR photo, autographed! Incidentally, what can you tell me about Maurie Blumenthal of WGN Drake hotel orchestra fame? I have a case and want to be cured. Five children and a wife might help, or even his picture.—Helen."

Another insult! Why you girls get the idea that I am a mere man, I can't fathom. But I won't send you my picture! Now about Maurie. He is NOT married! Went to University of Illinois. Is only twenty-three years old but he plays piano, arranges and sings as if he had years of experience. Since Maurie is matrimonially on the market, I will add that he drives a fast, rakish coupe and keeps the windshield and windows dusty so the public can't see him and his. Hair, black and straight; weight, about 165 pounds.

Harry Snodgrass, the "King of the Ivories?" I don't know where he is. Last I heard of him, which was, by the way, several months ago, he was doing a number of stations throughout the South. He and Witten are probably back in vaudeville, with an anti-Radio clause in their contract. These non-Radio-appearance contracts hurt an artist's popularity, don't you think?

The Gold Dust Twins prefer to remain a mystery. They are however, experienced artists (white) with enviable reputations behind the footlights. Olive says their southern melodies are best. Everyone agreed?

What deep secret would you like to know about your favorite broadcast star? Drop me a note, girls and boys, and I'll do by best to answer here. MARCELLA.

ADVANCE PROGRAMS FOR THE WEEK

Saturday, February 20

Headliners Today

Eastern	Central	Mountain	Pacific
7 p. m.	6 p. m.	5 p. m.	4 p. m.
WJZ (454.3m-660kc), Navy band concert.	WRC (468.5m-640kc), U. S. Navy band concert.		
8:15	7:15	6:15	5:15
WGY (379.5m-790kc), Fourth anniversary program.			
8:30	7:30	6:30	5:30
KDKA (309.1m-970kc), Westinghouse band concert.			
9			
WSM (282.8m-1060kc), Barn dance program.			
9:30			
WPAO (491.5m-610kc), Musical comedy troupe.			
WMAQ (447.5m-870kc), "George Washington."			
WTIC (476.9m-630kc), Arcadia Ladies' quartet.			
10			
WOR (405.2m-740kc), Serenaders' Plectrum quartet.			
10:45	9:45	8:45	7:45
KTBS (374.8m-800kc), Honolulu frolic.			
WSB (428.3m-700kc), Hired Help Skylark.			
11			
KFI (467m-642kc), All-American string quartet.			
KEJ (405.2m-740kc), Program, Treasure Hunt announcement.			
11:10	10:10	9:10	8:10
KGO (361.2m-830kc), "Olivette," comic opera.			
12 m.	11	10	9
KPRC (296.9m-1010kc), The Phantoms.			
2 a. m.	1 a. m.	12	11
KNX (386.9m-890kc), Filmland Frolickers.			

Saturday, silent night for: CFAC, CFCA, CNRA, CNBC, CNRE, CNRM, CNRR, CNRT, CNRV, CNRW, KFD, KFKX, KFKU, KFMX, KFRU, KFUO, KFXF, KKLX, KMA, KOAC, KOB, KQP, KSAC, KSO, KTAB, KWSC, WABQ, WCC, WDD, WEAQ, WEBJ, WEBW, WEEI, WGPC, WGST, WHAD, WHAZ, WGR, WHN, WHO, WIP, WJAR, WJAZ, WKAQ, WKAR, WLIT, WLWL, WMAZ, WMAI, WOS, WRVA, WTAG, WTIC, WWJ.

Eastern Time Stations

CHIC, Toronto, Can. (356.9m-840kc), 10:30 p. m., dance program, Al Linton's orchestra.
 CKNC, Toronto, Can. (356.9m-840kc), 4 p. m., chamber orchestra, Charles E. Bodley, director; Arthur VanderVoort, bass; Hazel Hall-VanderVoort, soprano; 8-10, Charles E. Bodley and his dance orchestra; Elgar male quartet.
 CNRO, Ottawa, Can. (434.5m-690kc), 7:30 p. m., Cossy Corner for girls and boys; Uncle Dick; 8, Chateau Laurier concert orchestra; 8:45, Alice Valliquet, soprano; Nico Poppeldoff, violinist; Chateau Laurier dance orchestra.
 KDKA, Pittsburgh, Pa. (309.1m-970kc), 7:15, 8 a. m., exercises, O. Shannon, conductor; 5:45, Daddy Winkum; 6:30, dinner concert, T. J. Vastine, conductor; 8:30, concert, Mrs. Edna Reed, contralto.
 PWX, Havana, Cuba (400m-750kc), 8:30-9:15 p. m., dance music; 9:25-10:10, concert.
 WAFD, Fort Huron, Mich. (275m-1090kc), 10-12 p. m., Harrington hotel dance music; 12, Elmer Buster club, p. m., Austin Wylie's Vocalion Recording orchestra; WAHG, Richmond Hill, N. Y. (315.6m-950kc), 12:03 p. m., Joe Zimmerman, pianist; 12 midnight, Weinzoff's concert orchestra.
 WBBR, New York, N. Y. (273m-1100kc), 8 p. m., Carl Park, violinist; 8:10, L. Marion Brown, soprano; 8:30, Carl Park, violinist; 8:40, "Comfort for the People," Bible discussion; 8:50, L. Marion Brown, soprano.
 WBZ, Springfield, Mass. (333 m-900kc), 6:30 p. m., Little symphony orchestra, KDKA; 6:45, Hotel Lenox ensemble; 7:45, Daniel Kuntz and his Repertory theater concert orchestra; 8:15, musical program, Hotel Brunswick studio; 9:15, violin recital, Evelyn LaFrance Daly; Mrs. Eleanor Turner LaZazzari, accompanist; 9:30, program, Louise Boyce, soprano; Thelma Bugbee, pianist and accompanist; 9:45, Lee Relman's Hotel Brunswick orchestra.
 WCAE, Pittsburgh, Pa. (461.3m-650kc), 3 p. m., music, Nixon Cafe; 6:30, dinner concert, William Penn hotel; 7:30, Sunshine girl; 8:15, Youngstown artists.
 WCX, Detroit, Mich. (516.9m-580kc), 6-7 p. m., dinner program, Goldkette ensemble.
 WEA, New York, N. Y. (491.5m-610kc), 6:45, 7, 7:20 p. m., "Tower Health Exercises," to WEA, WEEI, WCAP; 7:45-8, "Morning Prayer Service," under the auspices of the Greater New York Federation of Churches; 4 p. m., Louis Fisher's dance orchestra; 5, Vincent Lopez and his orchestra from Ritz Carlton hotel; 6, dinner music, Hotel Waldorf-Astoria; 7, Josephine Evans quartet; 7:15, Long Island Grotto B. U. G. club; 7:30, Josephine Evans quartet; 7:40, Long Island Grotto B. U. G. club; 7:55, "Character Sketches," Eugene Lincoln; 8:10, Einar Hansen, violinist; 8:30, Minnie Weil, pianist; 8:45, Irvine Floyer—on-air radio plays; 9:15, musical selections, string trio; 9:30, WEA musical comedy troupe; 10, Ross Gorman and his orchestra from Monte Carlo; 11-12 Vincent Lopez and his orchestra from Casa Lopez.
 WEAQ, Columbus, Ohio (293.9m-1020kc), 8 p. m., Michigan-Ohio State basketball game, A. Leo Henderson, announcer.
 WEAR, Cleveland, Ohio (389.4m-770kc), 7 p. m., Hotel Statler concert orchestra, Maurice Spitalny, director; 12 midnight, Wormack's singing syncopators.
 WEEI, Boston, Mass. (348.6m-860kc), 6:45 a. m., Tower health exercises; 8 p. m., Boston symphony orchestra, Serge Koussevitzky, conductor; 10, Lucerne Girls' quintet.
 WFI, Philadelphia, Pa. (394.5m-760kc), 10 a. m., meeting, American Academy of Political and Social Science, conference on Modern China, the Prevention and Detection—speakers, Hon. Ellen C. Potter; Fred L. Hoffman, William McAdoo, Chief Magistrate of New York; Joseph K. Willing; 1 p. m., tea room ensemble; 3, Peter Muhlenberg Chapter, Daughters of American Revolution; Puccini string trio; Helen Rowley, violinist; Jean Modave, cellist; Kathryn O'Boyle, pianist; Virginia Snyder, accompanist; soprano solos, Laura E. Manwaring, Fanny Shirver, accompanist; 6:30, Bellevue-Stratford concert orchestra; 7, Bellevue-Stratford dance orchestra; 8, musical program; 8:15, American Academy of Political and Social Science, speakers, Lynn G. Adams, Superintendent Penn. State Police; Mabel Willebrandt, Asst. Attorney General of U. S.; Edwin M. Abbott, Phila. Dept. of Public Safety; 9:15, studio program; 11, Bellevue-Stratford dance orchestra.
 WGBS, New York, N. Y. (315.6m-950kc), 1:30 p. m., Katherine Conolly, songs; 2, Joe Kahn, tenor; 3, Orpheus ensemble; 6, Uncle Gebebe; 6:30, Jacksonville Five; 7, Joseph Halligan, tenor; 8:30, Clifford W. Chesley, philosopher; 8:40, Domingo Diego, Spanish tenor; 9:20, Joseph Parisi, trumpeter; 9:30, Rita Redmond, soprano; 10, Bauna Gessner and Albert Carter, duets; 10:30, Arrowhead Inn dance orchestra.
 WGPC, New York, N. Y. (525m-1190kc), 3 p. m., Miami Ramblers; 3:30, Andy Razof; 3:45-4, program; 4:15, Joe Turkel, tenor; 4:30, Ramopo Ramblers; 5, William Goble, tenor; 8:30, Strickland's orchestra; 9, ukulele; 9:20, J. Lee, songs; 9:40, Jama Yama Boys; 10, Della Rioridan, female baritone; 10:15, program; 10:30, Strickland's orchestra.
 WGH, Clearwater, Fla. (266m-1130kc), 6:30-7:30 p. m., dinner music; 8:30-9:30, David Gootenberg, violinist; Marlon Hoffman, pianist; 11:45-1 a. m., Radio Ramblers' midnight frolic.
 WGY, Schenectady, N. Y. (379.5m-790kc), 6:30 p. m., dinner program; 8:15, program, celebrating Fourth Anniversary of WGY.
 WHAR, Atlantic City, N. J. (275m-1090kc), 2 p. m., Seaside hotel trio; 7:30, lecture period; 8, Seaside hotel trio.

WIP, Philadelphia, Pa. (508.2m-590kc), 6:45 a. m., setting-up exercises; 7, setting-up exercises; 10, menu talk, Mrs. Anna B. Scott; 10:30, reducing exercises; 1 p. m., organ recital; 3, Dal Ruch and his Arcadians; 8:05, Benjamin Franklin concert orchestra; 7, Uncle Wip; Ernest McCorkle, cornetists; 8, sports corner, Dr. Francois D'Eliseu; 10:05, Benjamin Franklin hotel El Patio orchestra; 11:05, organ recital.
 WJAX, Jacksonville, Fla. (336.9m-890kc), 3:30 p. m., Hemming Park band concert, Vessella's band, Oreste Vessella, conductor; 7:30, music memory contest; 8-10, popular program.
 WJR, Pontiac, Mich. (516.9m-580kc), 7 p. m., Jean Goldkette's symphony orchestra; 11:30, "The Merry Old Chief" and his "Jawet Radio Jesters."
 WJZ, New York, N. Y. (545.3m-660kc), 11 a. m., Philharmonic children's concert, Ernest Schilling, conductor; 7, U. S. navy night; 9:15, N. Y. public library concert, Lenox string quartet.
 WLIT, Philadelphia, Pa. (394.5m-760kc), 12:02 p. m., daily almanac; Arcadia cafe concert orchestra; Stanley theater organ recital; 2, Rose Tree Cafe orchestra; 4:30, dance orchestra; 7:30, Ben Franklin concert orchestra.
 WMAK, Buffalo, N. Y. (266m-1130kc), 6:15-7:15 p. m., dinner music; Hotel Lafayette trio; 7:30-8:30, musical program; 8:30-9, musical program, Wolff's Furniture House; 9-9:30, musical program, Beaver Products company; 9:30-10:30, musical program, Sunrise Point Development company.
 WMBF, Miami Beach, Fla. (384.4m-780kc), 7-9 p. m., Fleetwood Radio orchestra; 10-1 a. m., Gene Fosdick and his orchestra; Fleetwood Radio orchestra.
 WMCA, New York City, N. Y. (340.7m-880kc), 6 p. m.,

Olcott Vail and his Hotel McAlpin string ensemble; 6:30, Woodmanstein Inn orchestra; 7, Jack Denny's orchestra; 8, current events; 9, Tracy Pearl musical program; 10:30, Norman Pearce, readings; 11, Ernie Golden and his Hotel McAlpin orchestra.
 WNAC, Boston, Mass. (280.2m-1070kc), 6 p. m., The Smilers, Clyde McArdle, conductor; 6:30, Shepard colonial dinner dance, Billy Lossez, director; 8, program; 9, varied program, artists from De Vry entertainment service; 10, Copley-Plaza orchestra, W. Edward Boyle, director; popular selections, Jack Fay, Rose Goldbergs, accompanist.
 WNYC, New York, N. Y. (526m-570kc), 7 p. m., song recital; 7:35, The Seville trio; 8, Margaret Zeidler-Stiefel, soprano; 8:15, piano recital; 8:30, Margaret Zeidler-Stiefel; 8:45, piano recital; 9, Paul Hauesler, composer-pianist with assisting artists; 10:10, Travel Talk, board of education lecture series.
 WOO, Philadelphia, Pa. (508.2m-590kc), 11 a. m., organ recital; 12:02 p. m., Golden's crystal tea room orchestra; 4:45, organ recital; 7:30, A. Candelori's concert orchestra.
 WOR, Newark, N. J. (405.2m-740kc), 2:30 p. m., Zil's Central Park Casino tea music; 3:15, Triangle club, Princeton university; 6:15, Bill Wathey of the Telegram staff in sports; 6:30, Jacques Jacobs' Hotel Shelton ensemble; 7:30, Van's Collegians; 8, Phil Cook, the musical chef; 8:15, Mischa Goodwin, violinist; 8:45, Westall Jordan, tenor-cellist; 9, 9:15, LaFarge-Berumen, musicale; 10, Serenaders' Plectrum quintet; 10:30, Serenaders' Plectrum quintet.
 WPG, Atlantic City, N. J. (299.8m-1000kc), 1:30 p. m., Hotel Morton luncheon music; 6:45, Arthur Scott Brook, organist; 7, Hotel Ambassador dinner music; 8, dancing lesson; 8:15, dance music of all countries; 9, Hotel Traymore concert orchestra; 10, Nick Nichols' dance orchestra; 11, dance orchestra, Elks Home.
 WRC, Washington, D. C. (469m-640kc), 12 noon, organ recital; 1:00, L. Kitt studios; 1 p. m., Hamilton hotel orchestra; Daniel Chavon, director; 7, concert, U. S. navy band Lieutenant Charles Bentler, leader; 9:15, concert, WJZ; 10:30, Crandall's Saturday Nighters.
 WREO, Lansing, Mich. (285.5m-1050kc), 6-7 p. m., Speed-Wagon serenaders; Gold Standard ensemble; 10-12, Speed-Wagon serenaders.
 WTAG, Worcester, Mass. (268m-1120kc), 10:30 a. m., musical selections; 12:05-2 p. m., noonday luncheon music, WTAG orchestra, Will Hardy, director; 3-5, Tea Dansant music, WTAG orchestra; 5:15, "The Twinkle Twinkle Story Teller."
 WTAM, Cleveland, Ohio (389.4m-760kc), 12:30-1:30 6-7, Carl Rupp and his Hotel Hollenden orchestra; 8-9, Hollenden hour; 9-12, Ev Jones and his gang.
 WTC, Hartford, Conn. (475.9m-630kc), 6:30 p. m., "Skinny and his Gang"; 8:50, Hotel Bond trio; 8, Sunday school period, Prof. A. J. W. Myers; 8:30, Walter M. Cole and assisting artists; 9:30, Arcadia ladies quartet; 10:30, dance music, Emil Helmberger's Hotel Bond orchestra.
 WWT, Detroit, Mich. (352.7m-850kc), 9:30 a. m., "Tonight's Dinner"; 12:05 p. m., Jules Klein's Hotel Statler orchestra; 8, Detroit News orchestra.

Central Time Stations

CKY, Winnipeg, Can. (384.4m-780kc), 9 p. m., concert, J. A. Bandfield Limited, Royal Alexandra hotel.
 KFAB, Lincoln, Nebr. (340.7m-880kc), 5:30-6:30 p. m., dinner concert; 8:30-9:30, Schmolter and Mueller music; 12-2 a. m., orchestra.
 KFEQ, Oak, Nebr. (267.7m-1120kc), 2-3 p. m., Oak talent; 8:30-10, Hazel Olson.
 KFKX, Hastings, Nebr. (288.3m-1040kc), 5:30 p. m., dinner concert relay, KDKA; 9-2 a. m., program, Hotel Clarke studio; vocal and instrumental classical music; sacred devotional period; special and unique musical features; popular music by several orchestras.
 KFN, Shenandoah, Iowa (263m-1140kc), 7 p. m., Scotch concert, E. S. Dodds, director; 11, old-time fiddling.
 KFV, Columbia, Mo. (499.7m-600kc), 4:30-5:30 p. m., Bella Vista Quadrangle orchestra.
 KFEV, University City, Mo. (240m-1250kc), 9:15 p. m., amusement review, Romalene Fielding; dramatic readings; Solon Neeley, organist; harmonica duo.
 KLDS, Independence, Mo. (441m-680kc), 8 p. m., request program; Dr. Harry Cooper, organist; Mrs. E. N. Brinkman, contralto; E. N. Brinkman, baritone; Mrs. Harry Spokesfield, pianist; Louise Mason, soprano.
 KMA, Shenandoah, Ia. (252m-1190kc), 11:30-12:30 p. m., rural program; How do you do Boys, Grady and Dex; 6-7, popular dinner hour program; 9-11, pipe organ recital, William Howie.
 KMMJ, Clay Center, Nebr. (229m-1310kc), 1:30 p. m., Old Trusty special afternoon program; 8:30, brass band and solos.
 KMOX, St. Louis, Mo. (280.2m-1070kc), 12:30 p. m., organ recital, Arthur J. Utt; 3, string ensemble music with soloists; 4, string ensemble music with soloists; 6, organ recital, Arthur L. Utt; 7, Little symphony, David Blitner, Jr., conductor; the schoolmaster; Ada Stewart, soloist; 8, Little symphony; "Colonel 6121"; Oscar B. Franz quartet; 9, Little symphony; Jack Powers, baritone; 10, Little symphony; Clay Ballew, Negro spirituals.
 KOIL, Council Bluffs, Iowa (278m-1080kc), 5 p. m., Randall's Royal Fontenelle orchestra; 5:30, McCrory's music period, Cleo Kenase, conductor; 6:30, Randall's Royal Fontenelle orchestra; 7:30, program, Gene Stirling; 11, Hugo Heya and his Happy Hollow club orchestra; 12 midnight, Randall's Royal Fontenelle orchestra; Fontenelle pow-wow.
 KRC, Houston, Tex. (296.9m-1010kc), 12 noon, Jack Willrich's orchestra; Virginia Willrich, piano-accompanist; J. B. Zeller, novelty trap drummer; 7:30 p. m., Universal Bible class, Rev. Claude L. Jones; 8:30, Frank Tilton, boy pianist; 11, The Phantoms, "ghosts of the air."
 KSD, St. Louis, Mo. (545.1m-550kc), 7 p. m., Grand Central theater; 8:30, St. Louis symphony orchestra.
 KTBS, Hot Springs National Park, Ark. (374.8m-800kc), 9-9:30 p. m., Eastman hotel stringed quartet; 9:30-9:35, the Phantom Voice; 9:35-10:15, frolic, Meyer Davis' dance orchestra; Clyde Foley and Toni Cochard, comedy singers; 10:15-10:45, Mrs. Natalie Amoux, violinist; Elizabeth Bower, pianist; 10:45-11:15, Honolulu frolic, Big Four Waldman orchestra; Mr. Blake, steel guitarist.
 KWWG, Brownsville, Tex. (278m-1080kc), 6 p. m., The Sunshine Girl.
 KYW, Chicago, Ill. (535.4m-560kc), 6:30-7 a. m., exercises; 7:30, family worship; 1 p. m., concert, Commonwealth Edison company; 2, luncheon concert, Congress hotel, Jeska DeBabay and his orchestra; Cousins; 4, afternoon frolic; 6-7, dinner music, KDKA; 7:05, bedtime story, "Uncle Bob"; 7:30, home-lovers' hour; 8:30, Congress classic; 11:30, Congress carnival; 1 a. m., Insomnia club, Con-Sanders.
 WAMD, Minneapolis, Minn. (24m-1230kc), 12:01 p. m., trio, George Sawyer, Maurine Hefl, pianist; Henry Franson, tenor; 6:15, dinner concert, George Osborn and his orchestra; Elizabeth McKeever, soprano; Dr. Gordon Sandon, accompanist; 7:10, popular musical program, Harmony Twins, Bob Melcher, Fred Robie; Ruht Hokens, contralto; Dwyte Churchill, baritone; Willard Efav, pianist; 11, Sky Rocket frolic.
 WBBM, Chicago, Ill. (226m-1330kc), 4-6 p. m., Harry and Sandy; Valentino Inn orchestra; Johnny Black, Russell Meyers; Jack Fennewell and Freddy Palmeter; 8-9:30, musical comedy, "The Four Seasons"; 9:30-11, Sandy and Harry; Moulin Rouge orchestra; William E. Anderson, steel guitar; Sy Berg; Fred Jacobson; 11-2 a. m., Sunset quartet; WBBM harmony four; George Thurn, uke and kazoo; Two Jays; Charlie Garland; Spencer, Laverne and Shayne, xylophone; Joe Buck, uke and songs; Lew Russell; Romo Vincent; Moulin Rouge orchestra; Vivian Sheffer, contralto; Claire Matthews; Floyd Faleh; Arston trio.
 WCAL, Northfield, Minn. (336.9m-890kc), 8:30 p. m., music faculty.
 WCCO, Minneapolis-St. Paul, Minn. (416.4m-720kc), 12:30 p. m., noon concert, Emmet Long's Golden Pheasant orchestra; 2:30, afternoon concert; 6:15, dinner concert, Emmet Long's Golden Pheasant orchestra; 8:15, musical program; 10:05, dance program, Emmet Long's Golden Pheasant orchestra.



Tune in at 4:30 p. m. Central time Sunday afternoon for WBBM. Fawn Gray, a well-known dancer and entertainer, is the charming personality above, who makes this particular hour of the week attractive to listeners.

High Lights of the Week

NEVER to be seen is the fate of the "Ghosts of the Air" called the Phantoms at KPRC. But these disembodied spirits can play real jazz and may be heard Saturday evening as the clock nears twelve. Promptly at midnight a big Pow-Wow takes place at KOIL with Sitting on the Bull, conducting.

The two Kent artists this Sunday, are Lea Luboschutz, violinist, and Benno Moiseiwitsch, Russian pianist. Two Baltimore artists of note will entertain at WBAL this same evening, Pasquale Tallericco, pianist, and Margaret Rabold, former Metropolitan opera soprano.

Monday is Washington's Birthday. A special patriotic Radio pageant has been arranged by the Fort Crailo Post of the American Legion at WHAZ. The community program at WSAI, Cincinnati, has as the guest artist this week, Jeanette Vreeland, who sang recently over the WEAFF chain.

The famous violinist and concert-master of the Chicago symphony orchestra, Jacques Gordon, will play his famous "Clara Schumann Strad" over Station WGN, Tuesday. Another kind of fiddling may be heard at the

fiddlers' contest this same evening at WGY. Old-time fiddling has become popular again and almost every section has its old-time fiddlin' champion. Tuesday is also an auspicious day for KFNE. This station is now two years old and plans to run a twenty-six hour program.

A birthday party is a real birthday party when gifts are exchanged. CNRO will celebrate its anniversary Wednesday, with a special program and gifts to fans tuning in. WGR refuses to sign off until morning. This special frolic will last from 1 to 4:30 a. m.

Bulwer Lytton's powerful drama, "Richelieu," will be broadcast by the KGO players, Thursday night. Sixteen players will face the microphone. The American Croation glee club and the Tamburista orchestra are the interesting Thursday features at KDKA.

An oriental program will please the ladies Friday afternoon at WFI. Fairy tales of old Japan, and Chinese and Japanese music will make this program appealing. In the evening the opera "Faust" may be enjoyed at WEAR or the collegiate program by the Vanderbilt university at WSM.

MIDNIGHT POW-WOW FROM KOIL

Sunday, February 21

KOIL, Council Bluffs, Iowa (278m-1080ke), 11 a. m., First Congregational church service, Rev. J. B. Perkins, pastor; 1 p. m., dinner program, Randall's Royal Fontenelle orchestra; 7, Sleep Time Girl, Bernice Clizbe, conductor; 7:30, Monarchs, Jerry McMillen, conductor; 11, College club orchestra; Jamieson Oil duet, John Jamieson, John Halpien, Jr., Othelia Kinder, accompanist.

KPRC, Houston, Tex. (296.9m-1010ke), 10:45 a. m., service, First Christian church, Rev. Claude L. Jones, pastor; 7:30 p. m., South Main Baptist church, Rev. M. M. Wolf, pastor; 9:30 p. m., Silver-string players, pleatral orchestra, Mrs. Clarence L. Brook, director; D. W. Morris, soloist.

KSD, St. Louis, Mo. (545.1m-550ke), 6:15 p. m., St. Louis Post-Dispatch concert orchestra; 8:15, Atwater Kent Radio hour.

KTHS, Hot Springs National Park, Ark. (374.8m-800ke), 11 a. m.-12:15 p. m., services, First Presbyterian church; 9-10, classic hour, famous folk songs, New Arlington hotel grand ensemble, Lon Chassy, director; 10-11:30, Arkansas Traveler Limited, KTHS Radio Special train frolic; Benny Ford's orchestra.

KYW, Chicago, Ill. (535.4m-560ke), 11 a. m., Central church service; 2:30 p. m., Sunday afternoon; 7-9 p. m., Chicago Sunday Evening club; Grinnell college glee club; "How Jesus Made a Universal Religion," Dr. Cleland B. McAfee; address, Dr. Richard Roberts; 9, classical concert.

KWVG, Brownsville, Tex. (279m-1080ke), 2:30 p. m., church service.

WBAP, Fort Worth, Tex. (475.9m-630ke), 11 a. m., First Presbyterian church; 12:30 p. m., kiddies' hour; 5-6, Old Gray Mare band; 9:30-11, Chief Gonzales' Texas Hotel Royals.

WBBM, Chicago, Ill. (226m-1330ke), 12:30-2 p. m., classical program; William P. Zimmer, tenor; Harold Morava, lyric tenor; Kantor A. Kritz; Sandy Meek and Harry Sosnik; Edna Wheeler Ballard, harpist; Little Caruso and the Moulou Rouge operatic quartet; 4-6, Larry Shay; Lew Russell; Spencer, Lavergne and Shayne, xylophone; Pete Kules; Tip trio; Ziegler sisters; Two Jays; Harold Anderson; Charlie Garland; George Thum, uke and kazoo; Shayne melody monarchs; Rudy Winter; Floyd Falch; 8-10, Maurice Silverman; Moulou Rouge orchestra; Vivian Sheffer, contralto; Pauline Stiffer Atlas, violinist; Rudy Winter; Floyd Falch; 12-2 a. m., Nutty club; Moulou Rouge orchestra.

WCAL, Northfield, Minn. (336.9m-890ke), 8:30 a. m., Norwegian church service; 9:15 p. m., sacred program, Dr. Martin Hegland.

WCBD, Zion, Ill. (344.6m-870ke), 8 p. m., Zion orchestra, male quartet; P. D. Newcomer, cornetist; Fred Fasson, organist; Mrs. J. D. Thomas, soprano; Mrs. Mayfield, Mr. Reid; Mrs. G. R. Sparrow, contralto; M. P. Barton, tenor; Mrs. L. J. Hire, pianist.

WCCO, Minneapolis-St. Paul, Minn. (416.4m-720ke), 10:50 a. m., Hennepin Avenue M. E. church services, Lucius H. Bugbee, pastor; 3 p. m., Bible study, Lutheran Bible institute, Rev. Samuel M. Miller, dean; 4:10, House of Hope Presbyterian church, Rev. H. C. Swearingen, pastor; 8:20, Second Church of Christ, Scientist; 8:15, Atwater Kent program, WEAJ; Lea Lubostutz, violinist; Benno Moiseiwitsch, Russian pianist.

WDAF, Kansas City, Mo. (356.6m-820ke), 3-4 p. m., program, Harry Holmes, tenor; 4-4:45, Sabbath Vespers.

WEBB, Chicago, Ill. (370.2m-810ke), 10:45 a. m., Seventh Church of Christ, Scientist; 7-8 p. m., artists' program.

WFAA, Dallas, Tex. (475.9m-630ke), 2:30-4 p. m., music; 6-7, Bible class, Dr. William M. Anderson, pastor, First Presbyterian church; Bible study and Gospel song; 7:30-8:30, First Methodist Episcopal church service, Dr. Carl C. Gregory, pastor; Mrs. Robert H. Morton, soloist and director; 8:30-9:30, Earle Jackson and singers, Gaston Avenue Baptist church; 11-12, Ligon Smith and his orchestra.

WGES, Oak Park, Ill. (250m-1200ke), 10:15-12 noon, morning services, Dr. James L. Gardiner, Austin M. E. church, organ, choir; 5-7:30 p. m., Moody Bible school program, pipe organ; 11-12 midnight, organ, mezzo-soprano.

WGN, Chicago, Ill. (302.8m-990ke), 10:45-11:45 a. m., Uncle Walt; 11:45-12:45 p. m., Sunday noon musical hour, Chicago theater; 12:45-1:45, Chicago theater complete performance; 2-3, Edwin Stanley Seder's organ concert; Lyon and Healy studio; 3-4, concert, Chicago Philharmonic orchestra; 4-5, musical program; 5-5:15, old-time favorite songs; 7-7:30, musical program; 7:30-7:45, old-time favorite songs; 7:45-8:15, musical program; 8:15-9:15, Atwater Kent concert; 9:15-10, musical program.

WHAS, Louisville, Ky. (399.8m-750ke), 9:57 a. m., organ; 10, Broadway Christian church; 4:30-5:30 p. m., choral service, Christ Church cathedral.

WHB, Kansas City, Mo. (365.6m-820ke), 9:45-10:45 a. m., services, Linwood Boulevard Christian church; 11:15-12:30 p. m., services, Independence Boulevard Christian church; 8-9:15, services, Assembly church; 11:15-1 a. m., Linwood theater feature; Morrill Moore, organist.

WHO, Des Moines, Iowa (526m-570ke), 11 a. m., B'Nai Yeshurun congregation, Rabbi Eugene Mannheim; 7:30-8:30 p. m., Bankers Life trio; Myrtle Williams, soprano.

WIBO, Chicago, Ill. (226m-1330ke), 2-4 p. m., Sunday afternoon concert; Mr. Bunte and quartet, song biographies; Charlotte Edwards, contralto; Bernice Taylor, soprano; Chester Newman, baritone; 6-8, dinner concert; sacred songs, Walter Preston; WIBO string trio; Laura Remer, contralto; Sydney Elstrom, baritone; Helen Snyder, soprano; Earl Bigelow, pianist; 10-12, popular program; The Jordans, Irene Beasley, Everette G. Mitchell; Eugene Wallenius, tenor; Marie Tully, soprano.

WJAZ, Chicago, Ill. (322.4m-930ke), 7-9 p. m., musical program, Spanish Garden studio.

WJJD, Mooseheart, Ill. (370.2m-810ke), 7:45 a. m., Catholic services; 9:40-10:30, Protestant services; 3-4 p. m., Mooseheart Sunday concert.

WKAF, Milwaukee, Wis. (261m-1150ke), 4-6 p. m., Jean Hammond and her Tune Tinkers; Alvin Brooks, pianist; Otto Semper, tenor.

WKRC, Cincinnati, Ohio (422.3m-710ke), 6:45 p. m., Walnut Hills Christian church; 10, classical program; 11:30, Marion McKay and his orchestra.

WLIB, Chicago, Ill. (302.8m-990ke), 5-7 p. m., musical program.

WLS, Chicago, Ill. (344.6m-870ke), 6 p. m., prelude; 7-7:55, WLS little brown church in the vale; Little brown church choir; Ralph Emerson, organist.

WLW, Cincinnati, Ohio (422.3m-710ke), 9:30 a. m., school, editorial staff of Sunday School Publications, Methodist Book concern; 11, morning worship, Seventh Presbyterian church, Jesse Halsey, minister; 2 p. m., "The Eternal Tragedy," Passion play, broadcast from St. John's Catholic church; 7:30, services, First Presbyterian church, Dr. Frederick McMillan, pastor; 8:30, concert, H. & S. Pogue company, orchestra directed by Walter Esberger.

WMBB, Chicago, Ill. (250m-1200ke), 3-5 p. m., Trianon orchestra; Dell Lampe; Woodlawn theater orchestra; Walter Kippis; Lucille O'Hara, soprano; Tommie Hughes, baritone; Bob Duffy, singer and pianist; Ed Miller, tenor; 7:40-9, Fifth Church of Christ, Scientist, services; 9-11, Trianon orchestra; Dell Lampe; Woodlawn theater orchestra; Walter Kippis; Billie Allen Hoff, singer and pianist; Ed Graham, baritone; Bill Lightfield, tenor; Bob Bennett, pianist.

WMC, Memphis, Tenn. (499.7m-600ke), 11 a. m., services, Second Presbyterian church.

WOAI, San Antonio, Texas (394.5m-760ke), 11 a. m., First Presbyterian church service, Rev. Dr. P. D. Hill, pastor; 7:45 p. m., Central Christian church service.



The dare-devil gentleman, above, is Arthur H. Faust. He directs the WAMD players of Minneapolis. This is the way he looked in a recent play about pirates. To the right is a member of the Venetian trio, Genevieve Mead. This trio which comes from Dayton, Ohio, has become popular at WLW, Cincinnati.

WABQ, Haverford, Pa. (261m-1150ke), 11 p. m., Ardmore theater, Horace Hustler, organist; William Stew art, pianist.

WAFD, Port Huron, Mich. (275m-1090ke), 12-2 a. m., program, dance orchestra.

WAG, Richmond Hill, N. Y. (315.6m-950ke), 12:03 p. m., Grebe matinee trio; 7:30, Walter A. Tooss, novelty pianist; 7:50, Boy Scouts' program; 8, Synchrophase hour with Marie Nicholson; 8:15, aria from the Messiah—group of Scotch ballads and Care Selve; 9, Royal Whitmyer, tenor; 9:15, William Edelson, basso; 9:45, Royal Whitmyer, tenor; 10:03, Yama Yama boys; 10:20, Joe Zimmerman's orchestra; 12 midnight, Club Castle dance orchestra and Ukulele Bob MacDonald.

WBAL, Baltimore, Md. (246m-1220ke), 6:30 p. m., children's program; 6:30-7:30, WBAL dinner orchestra, Robert Iula, conductor; 7:30-8, organ program, Frederick D. Weaver; 8-9, musical program; Ruby Heritage, soprano; Edward Jendrek, tenor; Sol Sax, pianist; 9:10-10, musical program; Eugenia Arnold, contralto; Herbert Sokolove, violinist; Melvin Moritz, baritone.

WBRR, New York, N. Y. (273m-1100ke), 8 p. m., Syrian music, Prof. Toufic Moubaid and Elizabeth Awad; 8:30, "The Harp of God," Bible instruction; 8:45, Syrian music.

WBZ, Springfield, Mass. (333.1m-900ke), 6:30 p. m., KDKA Little symphony orchestra; 7:30, Rene Dagonis, organist; 8, Capitol theater orchestra; 8:30, patriotic program, Washington's birthday; 9, Aleppo Drum Corps; 9:30, WBZ Radio movie club.

WCAP, Washington, D. C. (468.5m-640ke), 6:45-7:45 a. m., Tower health exercises; 7-11 p. m., music; U. S. Marine band; guest soloist; Flora McGill Keefe, mezzo-contralto; A and P. Gypsies, WEAJ; opera, "La Sonnambula," WEAJ, Cesare Sodero, director.

WCAU, Philadelphia, Pa. (277.6m-1080ke), 7:30 p. m., recital, N. Snellenburg and company; 8, Carolyn Thomas, soprano; Ella Jaquette Kratz, pianist; 8:30, Ruppert and McCullough, banjoists; 8:45, recital; 9, Mails' Merry Minstrels; 9:30, Carl Smith and his Monday Nighters; 10, Arline R. Smith, soprano; Kathryn Fighorne, contralto, Sarah Snyder, pianist; 10:30, Paradians dance orchestra.



WOAW, Omaha, Neb. (526m-570ke), 9 a. m., chapel service, Rev. R. R. Brown; 1:30, matinee program; 6, Bible study, Mrs. Carl R. Gray; 9, chapel service.

WOC, Davenport, Iowa (483.6m-620ke), 1-2 p. m., Palmer Little symphony; Paul J. Vipperman, tenor; 2:30-3:45, Second Christian conference; 6:30-7, Methodist Episcopal church; 8:15-9:15, Atwater Kent program; 9:45-11:45, Palmer Little symphony.

WOK, Chicago, Ill. (217.3m-1380ke), 1-2 a. m., Tierney's Town club orchestra; Carl Lorraine's Pershing Palace orchestra; Husk O'Hare's Coconut Grove orchestra; program; 6-1 a. m., Tierney's Town club orchestra; Carl Lorraine's Pershing Palace orchestra; Husk O'Hare's Coconut Grove orchestra; Capitol theater musical program; program.

WOO, Kansas City, Mo. (278m-1080ke), 11-12:30 p. m., services; 7-7:45, services.

WORD, Batavia, Ill. (275m-1090ke), 10 a. m., service; 2:30 p. m., program, Chicago Rapid Transit company; 3:30, Bible lecture, John Read; 7, Webster hotel concert trio; 7:15, evensong; 9, Webster trio; 9:15, service; 9:30, address, G. A. Hall.

WOS, Jefferson City, Mo. (440.9m-680ke), 9:30 a. m., religious services, Christian church, Rev. Walter Hausbalter, pastor; 5 p. m., vesper services, Christian church; 7:30, services, First Christian church, Rev. R. M. Talbot, pastor.

WOL, Chicago, Ill. (447.5m-670ke), 9:30-11:30 a. m., People's church; 3-4 p. m., St. Ita's senior choir; Mrs. William P. O'Grady, director; 8-10, Rainbo Gardens orchestra; Fontella trio; Frederick Mueller, German tenor; Kathryn Diepenbrock, pianist; Jeanette Van Lennep, mezzo-soprano; Sheppard Levine, tenor; Grace Wallace, soprano.

WSAI, Cincinnati, Ohio (325.9m-920ke), 7:45 p. m., chime concert, Robert Badgley; 8, sermonette, Judge Thomas H. Darby; 8:15-9:15, Atwater Kent hour, featuring Lea Lubostutz, violinist; Benno Moiseiwitsch, Russian pianist; 9:15, Union Central Life Insurance company orchestra, Sigmund Culp, director.

WSB, Atlanta, Ga. (428.3m-700ke), 5 p. m., Methodist church choir; 7:30, North Avenue Presbyterian church service.

WSM, Nashville, Tenn. (282.8m-1080ke), 10:30 a. m., First Presbyterian church.

9, evening services, First Congregational church; 9-10, concert, Chevrolet Symphony orchestra.

KHJ, Los Angeles, Calif. (405.2m-740ke), 4-5 p. m., Masonic service; 7-7:30, service, Methodist Episcopal church, Arthur Blakely, organist; 8-10, program, Los Angeles Motor Car Dealers association.

KMX, Hollywood, Calif. (336.9m-890ke), 6:30-7 p. m., Unitarian church service; 8-9, First Presbyterian Church of Hollywood; 9-10:30, program, Beverly Hills Nurseries, Calmon Luboviski, master violinist.

KPO, San Francisco, Calif. (428.3m-700ke), 9:45-10:45 a. m., undenominational and non-sectarian church service; baritone solos, Ira Morgan; Uda Waldrop, organist; 5-6, organ recital, Marshall W. Giselman; 6-6:30, Waldemar Lind and the States restaurant orchestra; 6:35-8:35, Palace hotel concert orchestra, Cyrus Trobpe, director; 8:35-10, Rudy Seiger's Fairmont hotel orchestra.

KTAB, Oakland, Calif. (240m-1250ke), 9:45-10:45 a. m., Bible lecture, Prof. E. G. Linsley; 11-12:30, church services; 7:45-9:15, services; 9:30-11, after-service concert.

Monday, February 22

Headliners Today			
Eastern 7:35 p. m.	Central 6:35 p. m.	Mountain 5:35 p. m.	Pacific 4:35 p. m.
WNYC (526m-670ke) Chopin Anniversary program.	8:15	7:15	6:15
KDKA (309.1m-970ke), Washington's Birthday program.	8:30	7:30	6:30
WBZ (333.1m-900ke), Special Patriotic program.	9	8	7
WCCO (416.4m-720ke) University of Minnesota program.	10	9	8
WDAF (365.6m-820ke), Ivanhoe band.	10:30	9:30	8:30
WGST (270m-1110ke), Yellow Jacket Four.	10:45	9:45	8:45
WHAZ (379.5m-790ke) Students' Night, glee club.	11:30	10:30	9:30
WSB (428.3m-700ke) Agnes Scott glee club.	11:30	10:30	9:30
WTAG (268m-1120ke) Robin Hood hour of music.	11:30	10:30	9:30
WEAF (491.5m-610ke) "Cavalleria Rusticana," grand opera.	11:30	10:30	9:30
WGR (319m-940ke) Pilgrim quartet.	10:30	9:30	8:30
WLIT (394.5m-760ke), Fay's Vaudeville feature.	10:45	9:45	8:45
WTIC (275.9m-830ke) Studio program.	10:45	9:45	8:45
KTHS (374.8m-800ke) Novelty program.	11	10	9
WSAI (325.9m-920ke), Community program.	11:30	10:30	9:30
KOA (322.4m-930ke), Washington program.	11:30	10:30	9:30

Monday, silent night for: CNRA, CNRC, CNRE, CNRW, CNRO, CNRR, CNRT, CNRV, CNRW, KFAU, KFDW, KFEQ, KFMG, KFMK, KFWA, KHJ, KLDL, KYW, WBBM, WBCN, WCAD, WCBD, WCAJ, WEBB, WEJ, WEW, WENR, WGBS, WGES, WGO, WHAS, WHT, WIBO, WIP, WJAZ, WJJD, WKQA, WLIB, WLS, WMAQ, WMBB, WQAI, WOC, WOK, WORD, WQJ, WRG, WREO.

Eastern Time Stations
CKNC, Toronto, Can. (356.9m-840ke), 8-10 p. m., Little symphony orchestra; Aeolian quartet; Hazel Hall-Vandervoort, soprano.
KDKA, Pittsburgh, Pa. (309.1m-970ke), 6:30 p. m., dinner concert; 8:15, Washington birthday program; 9, Rudd Light Opera hour.
PWX, Havana, Cuba (400m-750ke), 8:30-9:15 p. m., Westinghouse concert; 9:25, musical program; 10:20, concert.

WCX, Detroit, Mich. (516.9m-580ke), 6-7 p. m., dinner program, Goldkette ensemble; 8-9, program.

WEAF, New York, N. Y. (491.5m-610ke), 10:30-12 noon, the Sons of the Revolution, Washington birthday program, direct from Carnegie Hall; 4-4:45, William Scott and his Club Florida orchestra; 5-6, Vincent Lopez and his orchestra from the Ritz Carlton hotel; 6-7, dinner music, Hotel Waldorf-Astoria; 7-7:20, Columbia university lecture; 7:30-8, Lullaby Lady; 8:45-9, Tower health talk; 9-10, A. and P. Gypsies; 10-11, grand opera, Cavalleria Rusticana; 11-12 midnight, Ben Bernie and his Hotel Roosevelt orchestra.

WEAO, Columbus, Ohio (293.9m-1020ke), 1:30 p. m., music.

WEAR, Cleveland, Ohio (389.4m-770ke), 7 p. m., Allen theater orchestra.

WEEI, Boston, Mass. (348.6m-860ke), 6:45 a. m., Tower health exercises; 2 p. m., Central Auto Tire company program; 5, Rainbow Ramblers orchestra; 6:15, Joe Binca and his Hunters' Cabin orchestra; 6:45, Big Brother club; 7:30, Warren Wardle, baritone; Miss Wardle, pianist; 7:45, John Kirwan, mandolinist; 8, Black Iron Shiners; 8:45, health talk, WEAJ; 9, A. and P. Gypsies, WEAJ; 10, Scotty Holmes and his orchestra, Imperial Marimba band.

WFI, Philadelphia, Pa. (394.5m-760ke), 10:30 a. m., music; 10:40, Betty Crocker; 1 p. m., tea room ensemble; 3, patriotic concert; talk, "George Washington," Mabel Swint Ewer; Lester Druckenmiller, violinist; Loretta Kerk, pianist; Edna Moore, soprano; 6:30, Bellevue Stratford concert orchestra; 7, Bellevue Stratford dance orchestra.

WGCP, New York, N. Y. (252m-1190ke), 3 p. m., Eva Rothenberg, pianologue; 8:20, Lefroy Mortenson, tenor; 3:45, program; 4:15-5, Uncle Robert's pals; 5:10, Follick and Dora; 8:30, Strickland's orchestra; 9, Madame Natanael, soprano; 9:15-9:45, program; 10, Strickland's orchestra.

WGHB, Clearwater, Fla. (266m-1130ke), 6:30-7:30 p. m., dinner music; 8:30-9:30, Ross sisters, ukulele accompaniment; 11:45-1 a. m., Radio Rambler midnight frolic.

WGPH, Detroit, Mich. (270m-1110ke), 6-7 p. m., dinner concert, Hotel Tuller; 7:30-7:50, children's evening chat; 8-10, Little symphony orchestra, Dirk Van Emmerik, conductor; T. Stanley Perry, tenor; 12-1 a. m., Gerald Marks and his orchestra.

WGR, Buffalo, N. Y. (319m-940ke), 2:30 p. m., WGR's afternoon program; 6:30, "The South-Bound Shufflers"; 8, Danny Engel's popular program; 8:30, variety program by R. R. Hill; 9:30, Mary Louise Conover, recital; 10, Pilgrim Male quartet; 11, Vincent Lopez' Hotel Statler dance orchestra, Harold Gieser, director, John F. Gunderman, Jr., organist.

SYMPHONY CONCERTMASTER AT WGN

Tuesday, February 23

Twins: 9, Eveready hour; 10, Moments musicale; 10:30, Vincent Lopez and his dance orchestra.
WGBS, New York, N. Y. (315.6m-950kc), 1:30 p. m., Viola Reed, soprano; 3, Interview with Dwight Frye of the Goat Song; 3:15, Idelle Nicotia, soprano; 3:20, interview with Ann Colman Ladd, sculptress; 8, Uncle Geese; 7, Arrowhead lun concert orchestra; 8, Y. M. H. A. vocalion form; 8:15, Alfred Shotton, concert violin; 8:50, Belle Bart; 9, Crystal Palace orchestra; 9:40, Jascha Gurtiwlich; 10:30, Arrowhead Inn dance orchestra.
WGPP, New York, N. Y. (252m-1190kc), 3 p. m., Irving Friskenberg, pianist; 3:20, Paul Hoxan, tenor; 3:35, Isabelle Henderson, soprano; 3:45, 20th Century entertainers; 4:15, Leslie McLeod, tenor; 4:30, Max Hecht, violinist; 4:45, Bob McDonald, ukulele.
WGH, Clearwater, Fla. (268m-1130kc), 6:30-7:30 p. m., dinner music; 8:30-9:30, Rex Danzler, tenor; Caroline Lee, "The Virginia Girl" and her Spanish guitar; 11:45-1 a. m., Radio Ramblers midnight frolic.
WGHP, Detroit, Mich. (270m-1110kc), 6-7 p. m., dinner concert, Hotel Tuller; 7:40-7:50, children's evening chat; 8-10, Skyline dance band; 12-1 a. m., Gerald Marks and his orchestra, assisting artists
WGR, Buffalo, N. Y. (319m-940kc), 2:30 p. m., WGR's afternoon program; 6:30, Vincent Lopez' Hotel Statler dance orchestra, Harold Gieser, director; 8, jointly with WEAJ, including Blue Ribbon male quartet, the Gold Dust Twins, Eveready hour, Moments musicale, and Vincent Lopez and his Casa Lopez orchestra.
WGY, Schenectady, N. Y. (379.5m-790kc), 6:30 p. m., Hotel Van Culler orchestra; 7:45, Marine band; 8, final, Old Fiddler's contest; 8:30, New York Philharmonic concert.
WHAR, Atlantic City, N. J. (275m-1090kc), 2 p. m., Seaside hotel trio; 7:30, talks; 8, Seaside hotel trio; 11:15, Strand theater organ recital.
WIP, Philadelphia, Pa. (508.2m-590kc), 6:45 a. m., setting-up exercises; 7, setting-up exercises; 10, menu talk; Mrs. Anna B. Scott; 1 p. m., organ recital; 3, Frank Brightman, pianist; Ellen Ayars, pianist; Edwin Fredericks, violinist; Bernard Otto, violinist; Grayce Mackey, reader; 6:05, Monte Cross, "Oldtimer"; 6:15, Nelson Napes and his S. S. Leviathan orchestra; 7, Uncle Wip's bedtime stories; songs by Amelia Roland; 8:15, artist recital; 10:30, Pagoda cafe orchestra.
WJAX, Jacksonville, Fla. (336.9m-890kc), 3:30 p. m., Hemming Park band concert, Vessella's band, Oreste Vessella, conductor; 7:30, music memory concert; 8-9, popular program; 11-12, popular program.
WJR, Pontiac, Mich. (516.9m-590kc), 7 p. m., Storm-foltz-Loveley entertainers; 9, Michigan night, university hall.
WLIT, Philadelphia, Pa. (394.5m-760kc), 11 a. m., organ recital; 12:02 p. m., daily almanac; Stanley theater organ recital; Arcadia cafe concert orchestra; 2, Arcadia cafe concert orchestra; 7:30, Dream Daddy's bedtime stories.
WMAK, Buffalo, N. Y. (266m-1130kc), 6:15-7:15 p. m., dinner music.
WMBF, Miami Beach, Fla. (384.4m-780kc), 7-9 p. m., Fleetwood Radio orchestra; 10-1 a. m., Gene Posdick and his orchestra; Fleetwood Radio orchestra.
WMC, New York, N. Y. (340.7m-880kc), 6 p. m., Olcott Vail and his Hotel McAlpin string ensemble; 6:30, Woodmansten Inn orchestra; 7, Jack Denny's orchestra; 8, Pace institute program; 8:15, Landay revelers; 9:15, Palmer pen lesson; 11, Ernie Golden and his Hotel McAlpin orchestra.
WNYC, New York, N. Y. (526m-570kc), 7:10 p. m., The Canadians; 7:35, The Canadians; 8, recital-talk, Herman Neuman and assisting artists, music of George Frederik Handel; 10, Harry Ash's orchestra; 10:35, Harry Ash's orchestra.
WOP, Philadelphia, Pa. (508.2m-590kc), 11 a. m., organ recital; 12:02 p. m., Golden's crystal tea room orchestra; 4:45, organ recital; 7:30, A. Candelieri's concert orchestra.
WOR, Newark, N. J. (405.2m-740kc), 6:15 p. m., Bill Wathey of the Telegram staff in sports; 6:30, Jacques Jacobs' Hotel Shelton ensemble.
WPG, Atlantic City, N. J. (299.8m-1000kc), 6:45 p. m., Arthur Scott Brook, organist; 7, Hotel Morton dinner music; 8:15, Cecile Steiner, violinist; Margaret Irwin, pianist; E. F. Gallagher, baritone; 9, Chalfonte-Haddon Hall dual trio; 10, Cuthbert Melody Boys, Pickers; 10:30, Karl Bonawitz, pianist; 11, Silver Slipper supper club.
WRC, Washington, D. C. (468m-640kc), 12 noon, organ recital, George Ross; 12:30 p. m., Lenten services, Keith's theater; 1, Hotel Washington orchestra, Irving Boernstein, director; 7:10, Radio School of International Relations; 7:30, concert, U. S. Marine band orchestra, Capt. William H. Santele, leader; 8:30, New York Philharmonic society; 9:30, announced; 10:30, W. Spencer Tupman and his Hotel Mayflower orchestra.
WREO, Lansing, Mich. (285.5m-1050kc), 6-7 p. m., Speed-Wagon serenaders; Gold Standard ensemble; 8:15, Reo Motor Car company band; C. Eugene Erb, concertist; Reo Motor Car company band glee club.
WTAG, Worcester, Mass. (268m-1120kc), 10:30 a. m., musical selections; 12:05-2, noonday luncheon music, WTAG orchestra, Will Hardy, director; 5:15, "The Twinkle Twinkle Story Teller"; 9-10, Eveready hour, WEAJ; 10-10:30, "Moment Musicale," WEAJ; 10:30-11, Vincent Lopez and his orchestra.
WWJ, Detroit, Mich. (352.7m-850kc), 9:30 a. m., "Tonight's Dinner"; 12:05 p. m., Jules Klein's Hotel Statler orchestra; 3, Detroit News orchestra; 6, dinner concert; 8, concert, WEAJ.

ders' orchestra; 2:35-4, frolic, Frank Clark, director; Wendell Hall; 6-7, KDKA; 8, music, Congress hotel; 9, an hour of music; 10, evening at home; Coon-Sanders' orchestra; Wendell Hall.
WBAP, Fort Worth, Texas (475.9m-630kc), 6-6:30 p. m., Chief Gonzales' Texas Hotel Royals; 7:30-8:30, Marinba club; 9:30-11, WBAP's Harmony trio.
WCCO, Minneapolis-St. Paul, Minn. (416.4m-720kc), 2:30 p. m., afternoon concert, Dick Long's trio; 4, readers' club, Eleanor Pochler; 5:30, children's hour; 6:15, dinner concert, Dick Long's Nankin cafe orchestra; 7:30, program, WEAJ; 7:30-8, Gold Dust Twins; 8-9, Eveready hour.
WDAF, Kansas City, Mo. (365.6m-820kc), 3:30-4:30 p. m., the Star's string orchestra; 6-7, the Tell-Me-a-Story lady; the Trianon ensemble; 11:45-1, Ted Weem's Victor Recording orchestra; Eddie Kuhn's Kansas City Athletic club orchestra; Ted Meyn, organist.
WEBH, Chicago, Ill. (370.2m-810kc), 7 p. m., Oriole orchestra; 8, Lydella Lehner, contralto; Kathryn Forbes, soprano; 9, Uptown theater; 11, Oriole orchestra; 12:30 a. m., Jack Penneville, Fred Palminter.
WGES, Oak Park, Ill. (250m-1200kc) 5-7 p. m., tenor, organ, features; 8-9, flute duo orchestra, pipe organ; 11-1 a. m., pipe organ, tenor, piano and soprano selections.
WGN, Chicago, Ill. (302.8m-990kc), 10-10:15 a. m.,

phonic players; Palmer House Victorians; Howard L. Peterson, organist; 8-9, solos, bands, etc., children; 10-11, Garod studio; Rushmore ensemble singers; Palmer House Victorians; 12:30 a. m., Knights of the Burning Candle.
WKRC, Cincinnati, Ohio (422.3m-710kc), 10 p. m., Alvin Roehr and his Hotel Alms orchestra; 11, Doc Howard and his Cuvier WKRC quartet, orchestra; Reine Gaur, Phil Pavay, Ohio Grimm, Jimmie Schube.
WLII, Chicago, Ill. (302.8m-990kc), 7-8 p. m., musical program; 11-1 a. m., dance music, songs, Corroll and Gosden; Hawaiian guitar music, Langdon brothers.
WLS, Chicago, Ill. (344.6m-870kc), 6 p. m., WLS trio; 6:40, Ralph Emerson, organist; 7, lullaby time; 7:20, "Common Sense of Music," Dr. S. Spaeth.
WLW, Cincinnati, Ohio (422.3m-710kc), 7:30 a. m., healthful exercise, William Svadunum, physical department YMCA; 8, morning devotions, auspices of Parkway YMCA; 12 noon, noon concert, Hotel Gibson orchestra, Robert Visconti, director; 4 p. m., talk, Ralph Schmidt, of Ft. Thomas Kentucky; 4:10, French lessons, Madame Ida Telpmidis; 7, historical appreciation of music, Etelea Evans, Cincinnati Conservatory of Music; 7:30, piano memorize, Crosley piano request, Lady Mary Louise Wozeszek; 8, concert, Tenth U. S. Infantry band; concert Formica concert orchestra, Wil-

Gardens orchestra; Kenneth Sterling, baritone; Katherine McDevitt, Margaret McDevitt, piano duets; 10-1, Rainbo Skylarks; Gertrude Wolf Quentin, soprano; Jerry Sullivan; Rose Vanderbosch, soprano; Hal Lansing, ukulele soloist; Merrill Carter, baritone; Will Rossiter; Ila Shannabrook, soprano; Romo Vincent, boy baritone; 1-2, Glines hour.
WSAI, Cincinnati, Ohio (325.9m-920kc), 5:30 p. m., musical; 6:30, musical; 7, Mahley and Carsey orchestra, Reuben Lawson, director; 8, Eveready hour; 9:30-10, musical program; 12, Freda Sanker's orchestra.
WSB, Atlanta, Ga. (428.3m-700kc), 3 p. m., program, Remington Typewriter company; 10:45, entertainment.
WSM, Nashville, Tenn. (282.8m-1060kc), 10 p. m., frolic, Beasley Smith's orchestra.
WSOE, Milwaukee, Wis. (246m-1220kc), 8:45 p. m., movie review, Peggy Patton; 9, classical musical program, Eva Case company.

Mountain Time Stations
CNRR, Regina, Can. (476m-640kc), 8 p. m., kiddies' bedtime story, Aunt Jenny; studio program, Queen City Mandolin club.
KFXF, Colorado Springs, Colo. (250m-1200kc), 8:30-10:30 p. m., Colorado's part in the Great Feminist movement, Lillian H. Kerr, director; "March of the Women," Silver Cliff club.
KOA, Denver, Colo. (322.4m-930kc), 12:15 p. m., Rialto theater organ; 5:30, Brown Palace string orchestra.

Pacific Time Stations
CNRV, Vancouver, Can. (291.1m-1030kc), 8:30 p. m., studio program, Men's Musical club; Dorothy Haddon, accompanist; Stanley Blish, conductor; 10:30, Cabaret Belmont orchestra, Bebe Muller, soprano.
KFI, Los Angeles, Calif. (467m-642kc), 5:30-6 p. m., Norman Harvey's orchestra; 6, nightly doings; 6:15, KFI's Seeing California; 6:30, vest pocket program; 6:45, Radiotorial period; 7-8, program arranged by Clarabelle Patten Wallace; 8-9, Al Wesson's dance orchestra; 9-10, Louise Krios trio, Virginia Flohri, soprano; 10-11, Paetard ballad hour with usual favorites.
KFON, Long Beach, Calif. (232.4m-1290kc), 6-6:30 p. m., Brayton's theater organ; 6:30-7, amusement information; 7-8, California Foot Warmers orchestra; 8-9, Press-Telegram studio; 9-11, Long Beach Aero club hi-hinks.
KFWB, Hollywood, Calif. (252m-1190kc), 5-6 p. m., Big Brother of KFWB in children's stories; 8-9, Jack Smith's dance orchestra, Hazel Thomas, soprano; Blanch Kammer, pianologue; 9-10, Mosley brothers, banjo duets; Henry Kaplan, pianist; Bill Blake, tenor; Mildred Bragdon, soprano; 10-11, Warner Brothers frolic, directed by Charlie Weikman.
KGO, Oakland, Calif. (361.2m-830kc), 7:15-7:30 a. m., health training exercises, Hugh Barrett Dobbs; 7:45, Pep class; 8:15-8:30, health training exercises; 11:30-1 p. m., concert; 4:30-5, Hotel St. Francis concert orchestra, Vinton LaBarrera, conductor; 5:30, "As a Woman Thinketh," Louise Landis; 6-6:35, Brookway and his orchestra; 8-9, Eveready program; Mishel Piarostro, violinist; Lev Shorr, Russian pianist; 9:15-9:30, Audrey Sage, clarinetist; Adele Meyer, accompanist; Harmonica quartet; 9:30, auction bridge feature; 10-12, dance music program, Givrin-Deuel's California Collegians.

CLASSICAL CONCERTS INDEX

Saturday, February 20			
Eastern 9 p. m.	Central 8 p. m.	Mountain 7 p. m.	Pacific 6 p. m.
WCAE, WEAJ, WMAA, WREO			
KGQ, KYW, WEAR, WENR, WMAQ, WNYC, WOAW, WOK, WBC			
KDKA, KFNE, KOIL, KSD, KYW, WBBR, WGN, WMBB, WNYC, WOAW, WQJ			
KPA, KPRC, KSI, KYW, WHAS, WIP, WLW, WORD, WSAT, WSOE			
KNX, KYW, WEAF, WMAQ, WMC, WOAW, WOC, WORD			
KGQ			
WCAE, WCAU, WEAJ, WEAR, WEEI, WJAB, WTAG, WWJ			
KYW, WAM, WBZ, WEAR, WGBS, WGCP, WKAQ, WLS, WORD			
KFDM, KPRC, KSD, WBZ, WCAU, WCBD, WCCO, WEAR, WGY, WEAR, WHT, WNYC, WQJ			
WEI, WJAB, WTAG			
KEJ, KNX, KTHS, KYW, WCCO, WFSA, WNYC, WOC, WQJ, WSOE			
KPVE, KHJ, KNX, KPO, KTHS, KYW, WHN, WKRC, WOC			
KEJ, KNX, WOC			
KNX			
Sunday, February 21			
Eastern 9 p. m.	Central 8 p. m.	Mountain 7 p. m.	Pacific 6 p. m.
WCAU			
WCAE, WCAU, WEAJ, WEAR, WEEI, WJAB, WTAG, WWJ			
KYW, WAM, WBZ, WEAR, WGBS, WGCP, WKAQ, WLS, WORD			
KFDM, KPRC, KSD, WBZ, WCAU, WCBD, WCCO, WEAR, WGY, WEAR, WHT, WNYC, WQJ			
WEI, WJAB, WTAG			
KEJ, KNX, KTHS, KYW, WCCO, WFSA, WNYC, WOC, WQJ, WSOE			
KPVE, KHJ, KNX, KPO, KTHS, KYW, WHN, WKRC, WOC			
KEJ, KNX, WOC			
KNX			
Monday, February 22			
Eastern 9 p. m.	Central 8 p. m.	Mountain 7 p. m.	Pacific 6 p. m.
KGQ, WCX, WEAF, WMAA, WREO, WWJ			
KMA, WCCO, WEAF, WEAR, WHAD, WJB, WOAW, WOK			
KFNE, KSD, WBBR, WBZ, WCAU, WCX, WHAR, WHT, WJAB, WLW, WMBB, WTAG, WTIC			
KFOA, KGO, KHJ, KPRC, WBBR, WCCO, WLW, WORD, WOS			
KMA, KPO, KPRC, KSD, KTHS, WAM, WCCO, WEAF, WEAD, WJAB, WOAW, WSUI, WTAG			
KGW, KHJ, KMA, KSD, KTHS, KWSC, WHN, WSAT			
KGW, WBAP, WSAT			
KEJ			
Tuesday, February 23			
Eastern 9 p. m.	Central 8 p. m.	Mountain 7 p. m.	Pacific 6 p. m.
KGQ, KMA, WEAR, WEBJ, WGBS, WHAD, WJB, WMAQ, WOAW, WOK, WOB, WTIC, WWJ			
KFNE, KSD, KYW, WEB, WCAE, WCAU, WCX, WEAR, WEBJ, WGB, WEAR, WHT, WLS, WMBB, WQJ, WRC, WTIC			

Wednesday, February 24
**Eastern
9 p. m.**
 WCAE, WEAJ, WMAA, WREO, WWJ

**Central
8 p. m.**
 KGQ, WEAR, WHAD, WJB, WMAQ, WOK, WTIC

**Mountain
7 p. m.**
 KFNE, KPRC, KSD, KYW, WAM, WBZ, WCX, WEAF, WEI, WHT, WLW, WMBB, WMCA, WQJ, WTAG, WWJ

**Pacific
6 p. m.**
 KFOA, KGO, KPRC, KSD, KYW, WBZ, WCCO, WDAF, WEI, WGB, WHAD, WHAS, WJAB, WMAQ, WOB, WOS, WORD

Thursday, February 25
**Eastern
9 p. m.**
 WBZ, WCX, WEAF, WIP, WMCA, WREO, WWJ

**Central
8 p. m.**
 KGQ, KSD, WEAF, WEAR, WGBS, WHAD, WJB, WMAQ, WOAW, WOK, WWJ

**Mountain
7 p. m.**
 KYW, WBBR, WBZ, WCAU, WCCO, WCX, WEAR, WEI, WGB, WGY, WEAR, WHT, WLS, WLW, WMBB, WOAW, WQJ, WTAG, WTIC

**Pacific
6 p. m.**
 KEJ, KLD, WBAP, WCAE, WCAU, WCBD, WCCO, WEAF, WEI, WGB, WHAR, WHAS, WJAB, WNYC, WOC, WORD, WRC, WASI, WSB, WTAG

Friday, February 26
**Eastern
9 p. m.**
 KGQ, WCX, WMAA, WREO, WWJ

**Central
8 p. m.**
 KGQ, WEAF, WGY, WEAD, WJB, WMAQ, WOK, WOB, WTIC

**Mountain
7 p. m.**
 KYW, WAHG, WAM, WBZ, WCAU, WCX, WEBJ, WEI, WHT, WLS, WQJ, WWJ

**Pacific
6 p. m.**
 KFDI, KFNE, KFOA, KGO, KHJ, KSD, KYW, WBAP, WBZ, WCAU, WDAF, WEEI, WHAD, WJAB, WMAQ, WMCA, WSAT

Saturday, February 27
**Eastern
9 p. m.**
 KFAB, KFDI, KOA, WCCO, WHAD, WMAQ

**Central
8 p. m.**
 KFAX, KFDM, KOA, WCCO, WHAD, WMAQ

**Mountain
7 p. m.**
 KFMX, KHJ, KNX, KPO

**Pacific
6 p. m.**
 KPO

Headliners Today

Eastern 7 p. m.	Central 6 p. m.	Mountain 5 p. m.	Pacific 4 p. m.
CNRD (494.5m-690kc) anniversary program.			
WBZ (333.1m-900kc), Pierlan trio.			
WTIC (475.9m-630kc), Hartford Saengerbund concert.			
WBZ (333.1m-900kc) Angelus quartet.			
WDAF (365.6m-820kc) American Legion program.			
WEAF (491.5m-610kc) Irvine players.			
KTHS (374.8m-800kc) Old Breakdown concert.			
WGR (319m-910kc) Variety program.			
KFI (467m-642kc) Ventura string quartet.			
KYW (535.4m-580kc) Wendell Hall, Red-Headed Music Maker.			
WSM (282.8m-1060kc) Shriners.			
WGB (319m-940kc), Special All Night frolic until 4:30 a. m.			

Wednesday, February 24

Headliners Today

Eastern 7 p. m.	Central 6 p. m.	Mountain 5 p. m.	Pacific 4 p. m.
CNRD (494.5m-690kc) anniversary program.			
WBZ (333.1m-900kc), Pierlan trio.			
WTIC (475.9m-630kc), Hartford Saengerbund concert.			
WBZ (333.1m-900kc) Angelus quartet.			
WDAF (365.6m-820kc) American Legion program.			
WEAF (491.5m-610kc) Irvine players.			
KTHS (374.8m-800kc) Old Breakdown concert.			
WGR (319m-910kc) Variety program.			
KFI (467m-642kc) Ventura string quartet.			
KYW (535.4m-580kc) Wendell Hall, Red-Headed Music Maker.			
WSM (282.8m-1060kc) Shriners.			
WGB (319m-940kc), Special All Night frolic until 4:30 a. m.			

Eastern Time Stations

CNRM, Montreal, Can. (410.7m-730kc), 8:30 p. m., instrumental concert night.
CNRO, Ottawa, Can. (434.5m-690kc), 7 p. m., children's half hour, Aunt Bessie; 8, Chateau Laurier concert orchestra; 8:45, second annual birthday party, CNRO; favorite artists.
KDKA, Pittsburgh, Pa. (309.1m-970kc), 12:30 p. m., Trinity church Lenten service; 6:30, dinner concert; 8:30, independent wall paper Pierrots; 9, Helen Greenwood, soprano; Hulda Ledridge, pianist; Vineat Koren, tenor; Natcho Vasileff, cellist.
PWX, Havana, Cuba (400m-750kc), 8-9 p. m., Cuban Army band; 9:15-10:15, Cuban Army band.
WAHG, Richmond Hill, N. Y. (315.6m-950kc), 12:03 p. m., musicale; 7:30 p. m., songs for little people, Helen Marshall; 7:45, John DeBueris, clarinet virtuoso and Vito Menella, Italian tenor; 8:15, joint recital, Michael Lambert, cellist and Eddythe Lambert, lyric soprano; 3, William Taylor, baritone; 9:15, Philipp

good health period; 10:15-10:45, entertainment for shut-ins; 11-11:30, morning organ concert, Chicago theater, Dean Fessler; 12:01-12:30 p. m., noon-hour entertainment for children; 12:40-1:30, luncheon concert music; 2:30-9, Lyon and Healy artists' recital; 3:25, Fort o' Missing Men; 3:30-4:15, tea time music; 4:30-5 organ recital, Edward Benedict; 5:30-5:57, Skeezix time; 6:30-6:45, dinner concert music; 8:45-7, old-time favorite songs; 8-9, Eveready hour; 9-10, musical program; 10-10:10, "Sam 'n' Henry," Radio comic strip; 10:10-10:15, old-time favorite songs; 10:15-11, dance music; songs, Corroll and Gosden, Freda Leonard and Jewell Barnett.
WHAS, Louisville, Ky. (399.8m-750kc), 1-2 p. m., Benson trio; 3-3:30, Mrs. Myrtle Fuiks Zahn, Jr., organist; 4-5, Music Box concert; 7:30-9, Eddie Rosson and his orchestra.
WHB, Kansas City, Mo. (365.6m-820kc), 7-7:30 p. m., dinner hour organ concert, Linwood theater, Morrill Moore; 8-10, feature program; G. L. Cowan, pianist; N. McDowell, Hawaiian guitarist; J. Savage, guitarist; H. Grovier, mauldo-cello; R. Anderson, mandolinist and uke soloist.
WHO, Des Moines, Iowa (526m-570kc), 2:15 p. m., Snow White, Marvel trio; 7:30-9, American Legion; 11-12 midnight, Bankers' Life Corn Sugar orchestra.
WIBO, Chicago, Ill. (220m-1330kc), 2-4 p. m., program for shut-ins; Ted Florito, pianist; Dan Russo, violinist; Marie Tully, soprano; Wayne Meyers, reader; Mr. Wallace, singer; Dorothy Day Dillow, soprano; 6-8, dinner concert; American ballads, Walter Preston; WIBO string trio; S. Bernice Taylor, soprano; Charlotte Edwards, contralto; Eugene Wallenius, tenor; Ruth Golt, pianist; 12, midnight jamboree; Dan Russo, violinist; Ted Florito, pianist; Wayne Meyers, reader; Marie Tully, soprano; Harry Davis.
WJLD, Muskegon, Mich. (370.2m-810kc), 12-1 p. m., Palmer House symphonic players; Palmer House trio; 2-3, Howard L. Peterson, organist; 4-5, music, Moosheart children; daily assembly of 1,250 children; Moosheart faculty talks; 5:30-7, Jack Nelson; Palmer House sym-

llam Stoess, director, auspices The Formica Insulation company.
WMAQ, Chicago, Ill. (447.5m-670kc), 4:45 p. m., pupils, Maurice Rosenfield; 8, Chicago theater organ; 9:30, Hotel La Salle orchestra; 9:30, Mrs. Elizabeth Jenks, soprano; 9:30, Elmhurst choral club.
WMBB, Chicago, Ill. (269m-1200kc), 7-8 p. m., Trianon duo; Grand Opera trio; Gertrude Burnham, coloratura soprano; 9-11, Trianon orchestra; Dell Lampe; Woodlawn theater orchestra; Walter Kipps; Eddie Matis and Billie Donovan; Ned Graham, baritone; Bob Bennett, pianist; Oxford Girls, vocal duo.
WMC, Memphis, Tenn. (499.7m-600kc), 8:30 p. m., Hofstead Bible class male quartet; 9, bridge game; 11, midnight frolic.
WOAN, Lawrenceburg, Tenn. (282.8m-1000kc), 9-9:30 p. m., Walter B. Seale and orchestra; 9:30-10, quartet, orchestra.
WOAW, Omaha, Neb. (526m-570kc), 12:45 p. m., Gilbert Jaffy and his Little symphony; 6, entertainment; 6:50, orchestra; 9, classical; 10:30, Herb Feterman and his Omadala orchestra; 12, Rialto theater alarm.
WOC, Davenport, Iowa (485.6m-620kc), 5:45-6 p. m., chimes; 7-7:30, Blue Ribbon male quartet; 7:30-8, Gold Dust Twins, WEAJ; 8-9, Eveready hour; 9-10, travel lecture; 10-11, Crescent orchestra; 12-3 a. m., Crescent orchestra, to be rebroadcast by WGY.
WOL, Ames, Iowa (270m-1110kc), 12:30 p. m., college chimes.
WOK, Chicago, Ill. (217.3m-1380kc), 4:30-7 p. m., Capitol theater organ; program; 10-1:30, Tierney's Town club orchestra; Carl Loraine's Pershing Palace orchestra; Husk O'Hare's Coccanut Grove orchestra; Capitol theater program; program.
WOQ, Kansas City, Mo. (278m-1080kc), 8-9 p. m., devotional musical program.
WORD, Batavia, Ill. (275m-1090kc), 7 p. m., program, Public Service company; 7:45, Bible questions and answers, E. M. Rice; 9-10, program, W. A. Shaeffer Fea company; 11-11:45, musical program, Public Service company.
WQJ, Chicago, Ill. (447.5m-670kc), 7-8 p. m., Rainbo

garden orchestra; Kenneth Sterling, baritone; Katherine McDevitt, Margaret McDevitt, piano duets; 10-1, Rainbo Skylarks; Gertrude Wolf Quentin, soprano; Jerry Sullivan; Rose Vanderbosch, soprano; Hal Lansing, ukulele soloist; Merrill Carter, baritone; Will Rossiter; Ila Shannabrook, soprano; Romo Vincent, boy baritone; 1-2, Glines hour.
WSAI, Cincinnati, Ohio (325.9m-920kc), 5:30 p. m., musical; 6:30, musical; 7, Mahley and Carsey orchestra, Reuben Lawson, director; 8, Eveready hour; 9:30-10, musical program; 12, Freda Sanker's orchestra.
WSB, Atlanta, Ga. (428.3m-700kc), 3 p. m., program, Remington Typewriter company; 10:45, entertainment.
WSM, Nashville, Tenn. (282.8m-1060kc), 10 p. m., frolic, Beasley Smith's orchestra.
WSOE, Milwaukee, Wis. (246m-1220kc), 8:45 p. m., movie review, Peggy Patton; 9, classical musical program, Eva Case company.

Eastern Time Stations

CNRM, Montreal, Can. (410.7m-730kc), 8:30 p. m., instrumental concert night.
CNRO, Ottawa, Can. (434.5m-690kc), 7 p. m., children's half hour, Aunt Bessie; 8, Chateau Laurier concert orchestra; 8:45, second annual birthday party, CNRO; favorite artists.
KDKA, Pittsburgh, Pa. (309.1m-970kc), 12:30 p. m., Trinity church Lenten service; 6:30, dinner concert; 8:30, independent wall paper Pierrots; 9, Helen Greenwood, soprano; Hulda Ledridge, pianist; Vineat Koren, tenor; Natcho Vasileff, cellist.
PWX, Havana, Cuba (400m-750kc), 8-9 p. m., Cuban Army band; 9:15-10:15, Cuban Army band.
WAHG, Richmond Hill, N. Y. (315.6m-950kc), 12:03 p. m., musicale; 7:30 p. m., songs for little people, Helen Marshall; 7:45, John DeBueris, clarinet virtuoso and Vito Menella, Italian tenor; 8:15, joint recital, Michael Lambert, cellist and Eddythe Lambert, lyric soprano; 3, William Taylor, baritone; 9:15, Philipp

CNRO'S BIRTHDAY PARTY WEDNESDAY

Wednesday, February 24

A. Fey, lyric tenor; 9:30, the Four Gondoliers; 10:03, Philipp A. Fey, lyric tenor; 10:20, Frank Lapeire's Collegians.

WBZ, Springfield, Mass. (333.1m-900ke), 6:30 p. m., KDKA Little Symphony orchestra; 8:45, Hotel Kimball dance orchestra; 8, Lillian Clark, harpist; Ethel Vanneman, soprano; Pierian trio; 9, Angelus quartet.

WCAU, Philadelphia, Pa. (277.6m-1080ke), 6:45 p. m., Parolians dance orchestra; 7:30, recital, N. Scollenburg and company; 8, talk; 8:10, Kane's Musical Advertisers; 9, Bigo's Royal Gypsy band; 9:30, Jones' Jolly Four; 10, fashion talk, Murray Elgart; 10:05, Interfraternally dance orchestra; 10:45, Frank Cook, old-time songs; 11, Artie Britton's Cheer-Ups.

WCX, Detroit, Mich. (516.9m-580ke), 6-7 p. m., dinner program, Goldkette ensemble; 8-9, program.

WEAF, New York, N. Y. (491.5m-610ke), 6:45, 7 and 8:20 a. m., Tower health exercises to WEAF, WEEL, WCAE; 7:45-8 a. m., morning prayer services, auspices of Greater New York Federation of Churches; 11:05, Evelyn Wight, soprano; 12 n., chapel services, Columbia university; 4, Marguerite Cartwright, soprano; 4:15, Juliette Glassman, pianist; 4:30, Ben Gordon, tenor; 4:45, story hour of New York public library; 5:00, Vincent Lopez and his orchestra from tea room of Ritz Carlton hotel; 6, dinner music, Rose room of Hotel Waldorf-Astoria; 7, synagogue services, auspices of United Synagogue of America; 7:30, concert, United States Army band, direction of William J. Stanward; 8:00, WCAE, WJAR, WOO; 8:30, Davy's saxophone octet, WEAF, WOO, WCAE, WSAI, WCAP, WTAG, WEEL, WGR; 9, Ipana Troubadours to WEAF, WEEL, WCAP, WWJ, WCO, WGR, WSAI, KSD; 10, Roxy and his gang to WEAF, WEEL, WTAG, WCAP, WWJ, WJAR, WGN; 5, Vincent Lopez and orchestra from Tea room of Ritz-Carlton hotel; 6, dinner music, Rose room of Hotel Waldorf-Astoria; 7, Gene Ingrassano and his Great Hotel Jan orchestra; 7:30, "St. Hubert's Cherry Tree," Blanche Wade to WEAF, WOO, WCAE, WGR, WJAR, WEAF, WTAG, WCO; 7:45, Modena Scoville, pianist; 8, the Happiness Candy Boys; 8:30, Eagle Neurodyne trio; 9, cilles service quartette and orchestra, WEAF, WEEL, WOO, WEAF, WGN, KSD; 9:30, Irvine players, one act radio plays; 10, Whittall Anglo Perclians, WEAF, WCAP, WJAR, WOO, WEEL, WGR, WTAG, WCAE, WCO, WCO, WWJ, KSD, WEAF; 10:30, Chamber music, Gene Zielinska, soprano, and Carl Rollins, baritone; 11-12 p. m., Ben Bernie and orchestra from Hotel Roosevelt.

WEAO, Columbus, Ohio (293.9m-1020ke), 4:10 p. m., story hour for shut-ins, Prof. Sada Harbarger; 8:15, music; 8:45, vocal; 9, two-planto recital.

WEAR, Cleveland, Ohio (389.4m-770ke), 7 p. m., Hotel Cleveland orchestra.

WEJ, New York, N. Y. (272.6m-1100ke), 8-8:30 p. m., John Landers and his Royal Aces; 8:45, Esther Littleman, concert pianist; 9 p. m., Benjamin S. Jarmus, tenor, accompanist, Milton Rubin; 9:15, Rudolph Jankovitz, concert violinist, accompanist, Norman Hennefeld; 9:30-10, Busoni's Neapolitans.

WEEL, Boston, Mass. (348.6m-860ke), 6:45 a. m., health exercises; 8 p. m., E. Payson Re and his orchestra; 5, Black and White vaudeville orchestra; 6:15, Joe Rines and his Hunters' Cabin orchestra; 6:45, Big Brother club; 7:30, Nordine Roberts, pianist; 8, musical skit; 8:30, Davy's saxophone octet, WEAF; 9, Ipana Troubadours, WEAF; 10, Roxy and his Gang, WEAF.

WFL, Philadelphia, Pa. (394.5m-760ke), 10:30 a. m., special music; 10:40, Betty Crocker; 1 p. m., tea room ensemble; 3, The Octave, of Haddon Heights; musical readings, Mrs. M. Alice Ermold; talk, "Care and Maintenance of a Lawn," Warren E. Meixner; 6:30, Bellevue Stratford concert orchestra; 7, Bellevue Stratford dance orchestra.

WGGS, New York, N. Y. (315.6m-950ke), 1:30 p. m., Ruth Maschke, soprano; 8, special hospital program for Reconstruction Hospital; 3:15, Sunny entertainers, Charlotte Salisbury singer, composer, actress; 6, Uncle Geehee; 6:30, Julie Wintz, Jersey Collegians; 7, Norbert Lusk, movie delight.

WGPP, New York, N. Y. (252m-1190ke), 3 p. m., Lillian Rubin, pianist; 3:20, Bobby Grey, singer; 3:45, Tracey and Mok; 4:30, Jeanne A. Dair, soprano; 5:10, Charlotte Trystmann, concert pianist; 7, Clarence Williams, trio; 7:25, Charles Coleman, pianist; 7:45, program.

WGH, Clearwater, Fla. (266m-1130ke), 6:30-7:30 p. m., dinner music; 8:30-9:30, Earl Gresh and his Gang Plank, Columbia Recording orchestra; Frank Wilson, tenor; 11:45-1 a. m., Radio Ramblers midnight frolic.

WGHP, Detroit, Mich. (270m-1110ke), 6-7 p. m., dinner concert, Hotel Tuller; 7:40-7:50, children's evening chat; 8-10, Little symphony orchestra, Dirk Van Emmorik, conductor; Mme. Gizi Szanto, pianist; quartet; 12-1 a. m., Gerald Marks and his orchestra, Hotel Tuller, assisting artists.

WGR, Buffalo, N. Y. (319m-940ke), 2:30 p. m., WGR's afternoon program; 6:30, Gospel melodists; 8, Audubon Terrace Meadow Larks; 8:30, jointly with WEAF, Davis saxophone octet; Ipana troubadours; 10, program, E. A. Willis Wallpaper company; 10:30, Mrs. Vernon Curtis in variety program; 11:30, Leola Nease Vickers, contralto, and associate artists; 12 Club Royale orchestra; 1 a. m., special all-night frolic program, including the Vincent Lopez Hotel Stalter dance orchestra, Harold Giesler, director, and other star performers, lasting until 4:30 a. m.

WGY, Schenectady, N. Y. (379.5m-790ke), 6:30 p. m., children's program; 7, Eastman theater orchestra; 8:05, musical program, WEAM.

WIP, Philadelphia, Pa. (508.2m-590ke), 6:45 a. m., setting-up exercises; 7, setting-up exercises; 10, reducing exercises; 1 p. m., Glimbel tea room orchestra; 3:15, recital, Montani studio; Flora Ripka, accompanist; 6:05, Benjamin Franklin concert orchestra; 7, Uncle Wip's bedtime stories; DeColibri's instrumental quartet.

WIAX, Jacksonville, Fla. (336.9m-890ke), 3:30 p. m., Hemming park band concert, Vessella's band, Oreste Vessella, conductor; 7:30, music memory contest; 8-10, popular program.

WJR, Pontiac, Mich. (516.9m-580ke), 7 p. m., Jean Goldkette's Symphony orchestra, soloists; 9, Winter Haven, Fla., Radio hour; 11:30, "The Merry Old Chief" and his "Jewett Radio Jesters."

WKAG, San Juan, P. R. (340.7m-880ke), 6-8 p. m., municipal band.

WLTT, Philadelphia, Pa. (394.5m-760ke), 12:02 p. m., daily almanac; Stanley theater organ recital; religious service; Arcadia cafe concert orchestra; 2, Arcadia cafe concert orchestra; 7:30, Dream Daddy's bedtime stories; 8, recital; 10, Arcadia cafe dance orchestra; 10:30, Dickerson's society orchestra.

WLW, New York, N. Y. (288.3m-1040ke), 9:15 p. m., entertainers; 9:45, McEvoy concert; 10:30 p. m., music and songs.

WMA, New York City, N. Y. (348.7m-880ke), 8 p. m., Oloft Yait and his Hotel McAlpin string ensemble; 8:30, Ernle Golden and his Hotel McAlpin orchestra; 7:45, Woodmanstein Inn orchestra; 8:20, talk on securities; 9, Coughlan & company entertainers; 11, Hofbrau Haus entertainers; 11:30, Jack Benny's orchestra.

WMAK, Buffalo, N. Y. (266m-1130ke), 7:30-10 p. m., musical program.

WMBF, Miami Beach, Fla. (384.4m-780ke), 7-9 p. m., Fleetwood Radio orchestra; 10-1 a. m., Gene Fosdick and his orchestra; Fleetwood Radio orchestra.

WNY, New York, N. Y. (526m-570ke), 5-5:45 p. m., Agnes Vernon's Juveniles; 6:30, piano selections; 8:30, elementary and advanced Spanish lessons, Y. H. Berlitz; 9:35, dance program; 8:30, instrumental novelty; 9, joint song recital; 9:30, stringed trio.

WOO, Philadelphia, Pa. (508.2m-590ke), 11 a. m., organ recital; 12:02 p. m., Golden's crystal tea room orchestra; 4:45, organ recital; 7:30, Hotel Sylvania dance orchestra; 8, Chamber music; 8:30, Davis saxophone octet; 9, concert; 10, Fox theater studio program; 10:30, Ritz Carlton dance orchestra.

WOR, Newark, N. J. (405.2m-740ke), 6:30 p. m., Jacques Jacobs' Hotel Shelton ensemble; 9:30, Veehawken Edus band.

WRC, Washington, D. C. (468m-640ke), 12 n., organ recital, Gertrude Smallwood; 12:30 p. m., Lenten services, Keith's theater; 1, Lee House trio, Sam Udrin, director; 4:15, Meyer Davis Le Paradis band; 5, musical program.

WRVA, Richmond, Va. (256m-1170ke), 8:10 p. m., orchestra and special features; 9:30, Richmond musicians club program, vocal and instrumental numbers; 11, Carry Me Back to Old Virginia.

WTAG, Worcester, Mass. (268m-1120ke), 10:30 a. m., musical program; 12:05-2, noon day luncheon music, WTAG orchestra; Will Hardy, director; 3-4:45, Pea Dantant music, WTAG orchestra; 7:15, "The Twinkle Twinkle Story Teller"; 8:30-9, Davy's Saxophone Octet, WEAF; 10-11, Roxy and his Gang, WEAF.

WTAM, Cleveland, Ohio (389.4m-760ke), 6-7 p. m., Royal Canadians; 8-11, city of Cleveland program; 11-1 a. m., Royal Canadians.

WTIC, Hartford, Conn. (475.9m-630ke), 6:30 p. m., Hotel Bond trio; 8, Hartford Saengerbund concert; 8:30, Genevieve Rose Faust, soprano; 9:15, Laura C. Gaudet, pianist; 9:30, Esther A. Nelson, organist; 10-11, dance music.

WWJ, Detroit, Mich. (352.7m-850ke), 7:30-8 a. m., setting-up exercises; 9:30, "Tonight's dinner"; 12:05, Jules Klein's Hotel Stalter orchestra; 8, Detroit News orchestra; 6, dinner concert; 8, News orchestra and soloists; 9, dance program; 10, Roxy and his gang.

Central Time Stations

CKY, Winnipeg, Can. (384.4m-780ke), 7:30 p. m., Canadian National Highway, program, Ft. Garry hotel.

CNRW, Winnipeg, Can. (384.4m-780ke), 7:30 p. m., bedtime story, Aunt Grace; 7:50, musical program, Ft. Garry hotel, Irvine Plumm and his orchestra; 8:45, studio program, brass band, Bandmaster J. T. Cocking, director; F. H. Hughes, baritone; 10, supper-dance program, Irvine Plumm and his Ft. Garry hotel orchestra; Al Kilgour, soloist.

KFKX, Hastings, Nebr. (288.3m-1040ke), 12:50, musical program, Hotel Clarke studio; 5:30, dinner concert relay, KDKA; 9, musical program, Sinfonia fraternity.

KFY, Shenandoah, Ia. (263m-1140ke), 7 p. m., concert, Henry Field Seed company.

KMOX, St. Louis, Mo. (280.2m-1070ke), 12:30 p. m., organ recital, Arthur L. Utz; 3, string ensemble music with soloists; operatic, "Marriage of Figaro"; 4, string ensemble music with soloists; 6, organ recital, Arthur L. Utz; 7, little symphony, David Blittner, conductor; Opal Sweage, soloist; 8, little symphony; Margaret Chapman Byers, oratorio and sacred selections with organ accompaniment; 9, little symphony; Alfred L. Schmier, pianist; 10, popular selections.

KFRD, Houston, Tex. (298.9m-1010ke), 12 noon, Lions' club luncheon program; I. C. Timmins; 5:30 p. m., Uncle Judd's kiddies' hour; 7:30, Fatty Martin's End O'Maine dance orchestra; 8:30, Rice Institute band; 60 pieces, Lee Chatham, director; 11, Palace theater orchestra, Charles MacBlain, director.

KSD, St. Louis, Mo. (545.1m-550ke), 7 p. m., Hotel Stadler orchestra; 8, Ipana Troubadours.

KTHS, Hot Springs National Park, Ark. (374.8m-800ke), 9-9:30 p. m., Salvatore Julian, trombonist; Toni Cochard, soloist, John Heyn, accompanist; grand ensemble, Lon Gessy, director; 9:30-10:15, "Old Breakdown concert," B. Smith and his fiddle band; 10-11:15, Southerners Majestic hotel dance orchestra.

KWVG, Brownsville, Texas (278m-1080ke), 12 noon, music; Beth Seville, pianist.

KYW, Chicago, Ill. (535.4m-560ke), 1 p. m., Congress hotel; 6, dinner music, KDKA; 7:30, Hearst square; 8, Congress hotel concert; 10-12:30, revue; 1-2, Linnonia club.

WBAP, Fort Worth, Tex. (475.9m-630ke), 12:05-12:30 p. m., Duda Vance, pianist; 6-6:30, Chief Gonzales' Texas Hotel Royals.

WBMM, Chicago, Ill. (226m-1330ke), 4-6 p. m., Harry and Sandy; Valentino Inn orchestra; Edna Wheeler Ballard, harpist; Harold Morava, tenor; Johnny Black, Court Banks, Ralph Bottorf; 8-10, barber shop three; Sy Berg and Bob Witt; Moulin Rouge orchestra; Phillip Nilles, tenor; Rudy Winter; Floyd Falch; 12-2 a. m., Lew Russell; Charlie Garland; Two Jays, Jeske and Jordan; Harold Anderson, accordionist; Moulin Rouge orchestra; Spencer, Lavergne and Shayne, xylophone trio; Claire Mathews; Floyd Falch; Aristocrat trio.

WCCO, Minneapolis, St. Paul, Minn. (416.4m-720ke), 2:30 p. m., afternoon concert; 4, readers' club, Eleanor Poehler; 5:30, children's hour; 7, midweek church service, Rev. M. C. Hartman, pastor; 8, program, WEAF; Ipana Troubadours; 9, musical program, the Nash-Flueh concert orchestra; 10:05, dance program, Wallie Erickson's Coliseum orchestra; 11:30, organ recital, Eddie Dunstetter.

WDAP, Kansas City, Mo. (365.6m-820ke), 6-7 p. m., The Toll-me-a-story lady; The Trianon ensemble; 8-10, program; 11:45-1, Ted Weem's Victor Recording orchestra.

WEBB, Chicago, Ill. (370.2m-810ke), 7-8 p. m., Emerson Military band; 9, Oriole orchestra; 9:45, Florence Behrend, soprano; Berni Dobers, pianist; 11, Oriole orchestra; Irene Beasley; Frank Bordner, revue.

WGN, Chicago, Ill. (302.8m-990ke), 10-10:15 a. m., good health period; 10:15-10:45, entertainment for shut-ins; 11-11:30, organ concert, Chicago theater, Dean Fessler; 12:01-12:30, noon hour entertainment for children; 12:40-2:30, luncheon concert music; 2:30-3, Lyon and Healy artist recital; 3:25, Port of Missing Men; 3:30-4:15, tea time music; 4:30-6, Skeetzie time; 6:30-8, dinner concert music; 6:45-7, old-time favorite songs; 8-9, musical program; 9-10, "Roxy" and his gang; 10-10:10, "Sam n Henry"; Radio comic strip; 10:10-10:15, old-time favorite songs; 10:15-11, dance music, songs, Correll and Gosen, Freda Leonard and Jewell Barnett; Hawaiian guitar music, Langdon brothers.

WHAS, Louisville, Ky. (399.8m-750ke), 1-2 p. m., Barney Rapp's orchestra; 3-3:30, Mrs. Myrtle Fuiks Zahne, Jr., organist; 4-5, Music Box review; 7:30-9, T. & I. orchestra; string division, K. & I. orchestra.

WHB, Kansas City, Mo. (365.6m-820ke), 2-3 p. m., ladies' hour program, Morrell Moore; 7-8, Milo Finley's trio; Walt Filkin, poet; popular songs, Wattie Watkins; Ramona Payne, pianist.

WHO, Des Moines, Ia. (526m-570ke), 2:15 p. m., Snow White, Marvel trio; 6-7, Bankers Life Little symphonic orchestra; 7-7:15, Uncle Dutch stories; 7:15-8:15, Irene Doran and her little symphony orchestra; 8-8:15, Harry Lewis; Norman Broholm, pianist; Kate Miller, whistler; Maude Hughes, accompanist; artists, Capitol theater; 9-12, dance program.

WIBO, Chicago, Ill. (228m-1330ke), 2-4 p. m., Shut-in program; Ted Florio, pianist; Dan Russo, violinist; Marie Tully, soprano; Wayne Meyers, reader; Connie Corwin, soprano; Russell Duke, singer; 6-8, dinner concert; old-fashioned songs; Walter Preston; WIBO string trio; Dorothy Rae, soprano; Florence Osterman, contralto; Joe North, baritone; Earl Bigelow, pianist; 10-12, popular program; open request night; Prof. Black, cryologist; Marie Tully, soprano; Heiky and Johnson; William Molinar, tenor; Edwin Cornelius, ukle soloist; Lenore Friedman, soprano; Pearl Holzman, pianist; Irene Beasley, the Jordans.

WIAZ, Chicago, Ill. (322.4m-930ke), 9-1 a. m., Spike Hamilton's and Al Katz' opera club.

WIJD, Mooseheart, Ill. (370.2m-810ke), 12-1 p. m., Palmer house symphonic players; Palmer house trio; 2-3, Howard L. Peterson, organist; 4-5, music, children; daily assembly of 1250 children; 5:30-7, Jack Nelson; Palmer house symphonic players; Howard L. Peterson, organist; Palmer house Victorians; 8-9, music, children; 10-11, Garod studio; R. V. Thomas; John Norton; Palmer House Victorians; 12:30, Garod studio; Palmer House Victorians; Jack Nelson.

WKAF, Milwaukee, Wis. (261m-1150ke), 10-11 p. m., Campus Skylarks; Al Buech, sax soloist.

WLBI, Chicago, Ill. (302.8m-990ke), 7-8 p. m., musical program; 11-1 a. m., dance music, songs, Correll and Gosen; Hawaiian guitar music, Langdon brothers.

WLS, Chicago, Ill. (344.6m-870ke), 6 p. m., WLS trio; 6:40, Ralph Emerson, organist; 7, Ford and

Glenn; 7:20, WLS trio; 8:30, "Our Dallas Trip," Ford and Glenn; 9:30, Jaysee male quartet; 10, Nadel's Hawaiian quintet; 10:30, Tony Corcoran, baritone; Mr. WLS trio.

WLW, Cincinnati, Ohio (422.3m-710ke), 7:30 a. m., healthful exercises, William Stradtman, physical department, Y. M. C. A.; 8, morning devotions, auspices of Parkway Y. M. C. A.; 12:05 p. m., musical novelties, Irene Downing, player-roll artist; 4, Shut-in program, directed by William Duning; 7, dinner hour concert, Hotel Gibson, orchestra directed by Robert Visconti; 7:30, address, a representative of the Ohio Farm Bureau federation; 10, concert, Sigma Alpha Iota sorority, Cincinnati conservatory of music; 11, Crosby male quartet; 11:20, Crosby musical news, Johanna Gross, editor and organist.

WMAQ, Chicago, Ill. (447.5m-670ke), 1 p. m., Chicago Association of Commerce luncheon; 2, shut-in program; 4:45, pupils, Cosmopolitan School of Music; 5:15, Georgene Faulkner; 6, Chicago theater organ; 6:30, Hotel LaSalle orchestra; 8:35, Marie Sidinius Zendt, soprano; 9, WMAQ players.

WMBB, Chicago, Ill. (250m-1200ke), 7-8 p. m., Trianon duo; Eleanor Kaplan, violinist; Edwin House, baritone; Preston Graves, pianist; 8-11, Trianon orchestra; Del Lampe; Woodlawn theater orchestra; Walter; Klippa, Cecl and Esther Ward, Hawaiian guitar artists; Bille Allen Hoff; Kreuger and Delton, banjoists; Ted and Ned, harmony duo.

WOAI, San Antonio, Texas (384.5m-760ke), 3 p. m., Radio Trades association concert; 8:30, army night program.

WOAW, Omaha, Nebr. (526m-570ke), 12:45 p. m., Phyllis Griswold, organist; 4:10, Feleman and Abbott.

WOC, Davenport, Ia. (483.6m-620ke), 4-4:45 p. m., Helen Hughes and her Blackhawk hotel; 5:45-6 p. m., chimes; J. W. Erwin Swindell, organist; 9:30-10:30, Augusta collage.

WORD, Batavia, Ill. (275m-1090ke), 7-7:45 p. m., program, the North Shore Line; 7:45-8, "The Harp of God"; 9, Webster hotel trio, I. B. S. A. choral singers; 11-12, program.

WQI, Chicago, Ill. (447.5m-670ke), 7-8 p. m., Rainbo Gardens orchestra; Dorothy Paxton, girl baritone; Jean St. Anne, baritone; Christian A. Grimm, pianist; Jessie Pringle, pianist; Agnes Pringle, violinist; 10-11, Rainbo Skylarks; Melodians; Clarence Theders, tenor; Jack Warner, character songs; George Thurm, kazoo; Oxford girls; J. Edwin Peterson, bass; 1-2, Ginger hour.

WSAI, Cincinnati, Ohio (325.9m-920ke), 7:30 p. m., Davy's Saxophone octet; 8, Ipana Troubadours; 10:15, Congress Playing Card string quartet.

WSB, Atlanta, Ga. (428.3m-700ke), 10:45 p. m., Biltmore hotel orchestra.

WSM, Nashville, Tenn. (282.8m-1060ke), 6:30 p. m., Francis Craig's orchestra; 7, WSM bedtime story; 8, Mrs. Daisy Hoffman, pianist; Mrs. Robert Luck, violinist; S. Shrimers.

WSMB, New Orleans, La. (319m-940ke), 9:30-12:30 p. m., Galio instrumental quartet; Paul Jacobs quartet; solos.

WSOE, Milwaukee, Wis. (246m-1220ke), 5:30 p. m., twilight musical; children's stories; Olga LaBelle, pianist; "Candygram" entertainers; musical selections; John H. Brown, basso; Mary Heimlich, pianist; H. H. Hagque, baritone; J. K. Hickman, one man band.

WVLI, Iowa City, Iowa (383.6m-620ke), 9 a. m., High School assembly program; 12:30 noon, music; 7:30 p. m., College of the Air.

Mountain Time Stations

KOA, Denver, Colo. (322.4m-930ke), 12:15 p. m., Marjorie Nash, organist; 6:30, Brown Palace string orchestra; 8, Scherman's Colorado orchestra; 8:15, Pi Kappa Delta studio program, Colorado Teachers' college male quartet; Carl Crist, baritone; Alexander Emslie, bass; J. Allen Grubb, tenor; Dorothy Becker, soprano; instrumental solos, Editha Todd, Clarence James, violinists; Lester Todd, cellist; Clarence James, violinist; Lester Opp, cellist; Louis Jones, pianist, four-violin ensemble, Edith Todd, Dorothy Milne, Myrna, Louise Snyder, Violet Finely; KOA orchestra; Colorado Teachers' college instrumental trio; 10-12, Broadmoor Rhythm Rustlers.

Pacific Time Stations

KFI, Los Angeles, Calif. (467m-642ke), 5:30-6 p. m., Oriole dance orchestra; 6, nightly dolms; 6:15, KFI's Sealing California; 6:30, vest pocket program; 6:45, Editorial period; 7, Nick Harris' Detective story; 7:20-8, dance music; 8-9, program, Ventura Reeling company; Ventura string quartet; 9-10, program, Chevrolet Motor company, Chevrolet ensemble; 10-11, Patrick-Marsh dance orchestra, Betty Patrick, soloist.

KFON, Long Beach, Calif. (232.4m-1290ke), 6-6:30 p. m., Brayton's theater organ; 6:30-7, amusement information; 7-8, Lulu Burnham entertainers; 8-9, Press-Telegram studio; 9-10, program, Sam Abrams, the talk; 10-11, Oriole dance orchestra.

KFWB, Hollywood, Calif. (252m-1190ke), 5-6 p. m., children's hour, Big Brother of KFWB; 8-9, program, John Wright, The Right Teller; John Wright orchestra, Sol Hoopii's Hawaiians, Frank Stever, baritone, Esther White, blues singer; 9-9:30 p. m., Bill Hatch and his Oakmont Country club dance orchestra; 9:30-10 p. m., Mutual Motors ninth concert; 10-11, Warner Brothers frolic, direction Charlie Westman.

KGO, Oakland, Calif. (361.2m-830ke), 7:15-7:30 a. m., health training exercises, Hugh Barrett Dobbs, William H. Hancock; 7:45, Pen class; 8:15-8:30, exercises; 11:30-1 p. m., Sherman, Clay and company luncheon concert; 3-4 p. m., Beulah Masterson, soprano; Jack Holworthy, tenor; LaLola Carow, soprano; 4-5:30, concert orchestra, Hotel St. Francis, Vinton LaFerrera, conductor; 5:30, Mr. Fix-it; 6-6:55, Brokaw and his orchestra.

KGW, Portland, Ore. (491.5m-610ke), 7:15 a. m., health exercises; 12:30-1:30 p. m., concert; 8-9, concert; 9-10, concert; 10-11, concert.

KHJ, Los Angeles, Calif. (405.2m-740ke), 6:30-7:30 p. m., history story, Prof. Herzog; Dick Winslow, juvenile reporter; Vivian Marple, Mickey McBan, screen juveniles; 8, lecture on astronomy, Dr. Mars Baumgard; 8:30-10:30, Oscar Seiling symphony orchestra.

KMTR, Hollywood, Calif. (238m-1260ke), 8-10 p. m., KMTR concert orchestra, Loren Powell, directing; 10-11, Starr Piano company studio.

Sunny Jim's talk; 5:30-6, Leighton's Arcade cafeteria orchestra; 6, Town Tattler; 6:15, travel talk, W. P. Alder; 6:30-7, Awtater Kent concert orchestra; 7-8, feature program; 8-9, program, Security Trust and Savings bank; 9-10, program, John A. Vaughn corporation; 10-11, dance music; 11-12, Ray West's Coconut Grove dance orchestra from Ambassador hotel.

KOAC, Corvallis, Ore. (289.2m-1070ke), 7:20 p. m., musical selection.

KPO, San Francisco, Calif. (428.3m-700ke), 7:30-8 a. m., daily dozen exercises; 12, scripture reading; 1-2, Rudy Seiger's Fairmont hotel orchestra; 2:30-3:30, program, James Lono's Hawaiians; 5:15-6:15, children's hour stories; 6:40-7, Waldemar Lind and the States Restaurant orchestra.

KWSC, Pullman, Wash. (348.6m-880ke), 7:30-9 p. m., Phil Epsilon steel guitar quartet; Vincent Hiden, cellist; Esther Olsen, reader.

NEWS BULLETINS

Daily Except Sunday

Eastern	Central	Mountain	Pacific
9:45 a. m.	8:45 a. m.	7:45 a. m.	6:45 a. m.
KDKA (309.1m-970ke), 10	9	8	7
WGN (302.8m-990ke), 10:35	9:35	8:35	7:35
WCCO (416.4m-720ke), 11	10	9	8
WOAI (394.5m-760ke), 12 n.	11	10	9
CFCA (356.9m-840ke); KDKA (309.1m-970ke); KPRC (296.9m-1010ke), 12:30 p. m.	11:30	10:30	9:30
WCAE (461.3m-650ke), 1	12 n.	11	10
KGW (491.5m-610ke); KNX (336.9m-890ke), 1:15	12:15 p. m.	11:15	10:15
WOAI (394.5m-760ke), 3:45	2:45	1:45 p. m.	12:45 p. m.
WLAS (398.8m-750ke), 4	3	2	1
WCX (516.9m-580ke), 4:30	3:30	2:30	1:30
WCAE (461.3m-650ke); WFAA (475.9m-630ke), 5	4	3	2
CFCA (356.9m-840ke), 6:30	5:30	4:30	3:30
WPG (299.8m-1000ke), 7	6	5	4
KOIL (278m-1080ke); WOC (483.6m-620ke), 7:15	6:15	5:15	4:15
WMAK (265.6m-1130ke); WOAI (394.5m-760ke), 8	7	6	5
WMBF (384.4m-780ke); WMCA (540.7m-880ke), 9	8	7	6
WSAI (325.9m-920ke), 9:30	8:30	7:30	6:30
KPO (428.3m-700ke), 10	9	8	7
KLX (508.2m-590ke), 10:45	9:45	8:45	7:45
WEBB (370.2m-810ke), 12	11	10	9

Sunday

Eastern	Central	Mountain	Pacific
8 p. m.	7 p. m.	6 p. m.	5 p. m.
WMAK (265.6m-1130ke), 8:15	7:15	6:15	5:15
WEBB (370.2m-810ke), 9	8	7	6
WPG (299.8m-1000ke), 12	11	10	9
KFPWB (252m-1190ke), 12	11	10	9

KYW, "The World Crier," broadcasts news every half hour from 8 a. m. to 2 a. m.

Eastern

Central	Mountain	Pacific
8 p. m.	7 p. m.	6 p. m.
KDKA (309.1m-970ke)	Glee club, Tamburita orchestra.	

WBZ (333.1m-900ke), Second Anniversary program.

WJZ (454.3m-860ke), WGY (379.5m-790ke), Royal hour.

9:45 8:45 7:45 6:45

WMC (499.7m-600ke), Cortese ensemble.

10:15 9:15 8:15 7:15

KTHS (374.8m-800ke), Spanish classics.

11 10 9 8

KGO (361.2m-830ke), "Richelleu," 5-act play.

KHJ (405.2m-740ke), Collegiate night.

KPO (428.3m-700ke), Radio Eight symphony.

KYW (535.4m-560ke), Wendell Hall.

12 11 10 9

WGCP (252m-1190ke), At Home party.

Thursday, silent night for: CHIC, GKNC, CNRA, CNRE, CNRO, CNRR, CNRT, CNRY, CNRW, KFAB, KFAU, KFDH, KFEL, KFEX, KFOA, KFUC, KFV, KFWA, KGW, KLX, KMOX, KOA, KOAC, KOB, KWSC, PWX, WABO, WAFD, WAHG, WCAP, WCEE, WDDD, WEAQ, WEBJ, WEBW, WHAD, WHAZ, WIJD, WOAI, WOR, WOS, WSM, WSUI, WTAM.

Eastern Time Stations

KDKA,

KGO PLAYERS TO GIVE "RICHELIEU"

Thursday, February 25

speaker; 6:30, Bellevue Stratford concert orchestra; 7:00, Bellevue dance orchestra, club program, direction Modern Club of Philadelphia; 8:00, The Larkinites; 8:30, Hires' Harvesters; 9:00, Cliequot Club Eskimos; 10:00, Goodrich Silvertown Cord orchestra.

WGBS, New York, N. Y. (315.6m-950ke), 1:30 p. m., Ramlers trio; 3:00, Prudence Penny's N. Y. American, Women in the Home; 3:15, hour with Renee Schimmell; 6:00, Uncle Geebee; 6:30, Perner-Stark orchestra; 6:40, Arthur Murray; 7:00, The Independent Magazine; 7:30, Ruth Maschke, soprano; 7:40, Erna Korn, contralto; 7:50 p. m., Irving Argy, concert violin; 8:30 Oliver Saylor, book and play review; 9:00, Crystal Palace orchestra; 9:30, Old Time Minstrels; 10:30, Vanderbilt hotel orchestra.

WGP, New York, N. Y. (252m-1190ke), 3 p. m., Elvira Resa Geiger, pianist; 3:20, Osborne and Tucker; 3:45, Davis and Gallasi; 4:45, Ernest Helm, violinist; Charlie Solisburg, singer; 5:10, Sylvia Schatz, pianist; 10:30, Irving Feinstein, pianist; 11:00, Piatini and Val, songs; 11:30, Strickland's orchestra; 12, at home party.

WGH, Clearwater, Fla. (266m-1130ke), 6:30-7:30 p. m., dinner music; 8:30-9:30, Bill Ewin, tenor; L. W. Joy, accompanist; 11:45-1 a. m., Radio Ramblers midnight frolic.

WGPH, Detroit, Mich. (270m-1110ke), 6-7 p. m., dinner concert, Hotel Tuller; 7:40-7:50, children's evening chat; 10-11, Skylark dance band and entertainers; 11-12, frolicers; 12-1 a. m., Gerald Marks and his orchestra.

WGR, Buffalo, N. Y. (319m-940ke), 2:30 p. m., WGR's afternoon program; 6:30, Vincent Lopez Hotel Statler dance orchestra, Harold Gleser, director; 8, jointly with WEA, The Larkinites; 9, jointly with WEA and Cliequot Club Eskimos and the Silvertown Cord orchestra.

WGY, Schenectady, N. Y. (379.5m-790ke), 6:30 p. m., Ten Eyck concert trio; 7:45, Syracuse university program; 9, Royal hour, WJZ; 10, WGY orchestra; Mario Bernstein, soprano; 11:30, Stephen E. Boisclair, organist.

WHAR, Atlantic City, N. J. (275m-1090ke), 2 p. m., Seaside hotel trio; 7:30, lecture period; 8, Seaside hotel trio; 9, studio concert; 11:30, dance orchestra.

WHN, New York City, N. Y. (361.2m-830ke), 12:30-1 p. m., Lexington organ recital; 3:15-4:30, Lexington orchestra; Treasure land neighbors; 7, Iceland orchestra; 8, Will Oakland's Chateau Shanley; 10:30, Kentucky club orchestra; 11, Joe Ward's Swane entertainers; 11:30, Everglades orchestra; 12, Parody club orchestra.

WIP, Philadelphia, Pa. (508.2m-590ke), 6:45 a. m., setting-up exercises; 7, setting-up exercises; 1 p. m., Gimbel tea room orchestra; 3, Albert Mahler, tenor; Charles Friedin, violin and saxophone; Laundon Stewart, pianist; Flora Ripka, accompanist; 6:05, Pagoda cafe orchestra; 7, Uncle Wip's bedtime stories; Dennis Sullivan, whistler; 8, "The Sequel-Centennial," talk by Harry A. Mackey; 8:15, United Synagogue radio service; 8:45, recital, Institute of Musical Art, Ben Stad, director; 10:15, Nelson Napes and his S. S. Leviantan orchestra.

WJAX, Jacksonville, Fla. (336.9m-890ke), 3:30 p. m., Hemming Park band concert, Vessella's band, Oreste Vessella, conductor; 7:30, music memory contest; 8-9, classical recital; 11-12, popular program.

WJR, Pontiac, Mich. (516.9m-580ke), 7 p. m., Jean Goldkette's Symphony orchestra; soloists; 9, Jean Goldkette's serenaders; soloists; 10, Jean Goldkette's Victor Recording orchestra.

WKAR, San Juan, P. R. (340.7m-880ke), 6-8 p. m., Rialto theater music.

WLT, Philadelphia, Pa. (394.5m-760ke), 12:02 p. m., daily almanac, Stanley theater organ recital; Arcadia cafe concert orchestra; 2, Arcadia cafe concert orchestra; 4:30, recital; 7:30, Dream Daddy's bedtime stories.

WLWL, New York, N. Y. (288.3m-1040ke), 9:00 p. m., book, Rev. Jos. McGorley; 9:15, Rhea Leddy and William Flusk; 9:30, question box; 10:00, Rhea Leddy and William Flusk.

WMAK, Buffalo, N. Y. (266m-1130ke), 6:15-7:15 p. m., dinner music.

WMBF, Miami Beach, Fla. (384.4m-780ke), 7-9 p. m., Fleetwood Radio orchestra; 10-1 a. m., Gene Posdick and his orchestra; Fleetwood Radio orchestra.

WMCA, New York City, N. Y. (340.7m-880ke), 6 p. m., Olcott Vail and his Hotel McAlpin string ensemble; 6:30, Woodmanstein Inn orchestra; 7, Jack Denny's orchestra; 7:30, Pace Institute program; 7:45, Tyrrell health talk; 8, Snedden Weir, baritone; 10:30, Jack Smith, whispering burlesque; 11, Ernie Golden and his Hotel McAlpin orchestra; 12 mid., Broadway night.

WNYC, New York, N. Y. (526m-570ke), 7 p. m., market high spots; 7:10, dance program; 7:35, A. Wayne, popular songs; 7:45, dance program; 8:30, German Irving Place theater ensemble; 9:30, Instrumental trio.

WOO, Philadelphia, Pa. (508.2m-590ke), 11 a. m., organ recital; 12:02 p. m., Golden's crystal tea room orchestra; 4:45, organ recital; 7:30, Adelphia dance orchestra.

WPG, Atlantic City, N. J. (299.8m-1000ke), 1:30 p. m., Hot Monday luncheon music; 6:45, Arthur Scott Brook, Hall afternoon tea music; 6:45, Arthur Scott Brook, organist; 7, Hotel Ambassador, dinner music; 8:15 concert, Atlantic City Board of Education; Royal P. MacLellan, tenor; Marushka Konrad, pianist; 10, Atlantic City Estates dance orchestra; 11, Eddie McKnight's dance orchestra.

WRC, Washington, D. C. (468m-640ke), 12 noon, organ recital; 12:30, Lenten services, Keith's theater; 1 p. m., Hotel Mayflower orchestra, Arsenio Ralon, director; 7, New Willard hotel orchestra, Samuel Korman, director; 8, concert, U. S. Army band, Capt. Wm. J. Starnard; 8:30, Radio-movie presentation; WJZ; 9, Royal Salon orchestra, WJZ; 10:15, The Record Boys, WJZ; 10:30, Meyer Davis' Swane orchestra; 11:30, organ recital, Otto F. Beck.

WREO, Lansing, Mich. (285.5m-1050ke), 6-7 p. m., Speed-Wagon serenaders; Gold Standard ensemble; 8:15, Reco Broadcasting orchestra; Reco string quartet; Leland C. Cooke, clarinetist; Accelerator male quartet.

WTAG, Worcester, Mass. (266m-1120ke), 10:30 a. m., musical selections; 12:05-2 noon, day luncheon, WTAG orchestra, Will Hardy, director; 4:30, entertainment; 5:15, "The Twinkle Twinkle Story Teller"; 8-8:30, "The Larkinites"; WEA; 9-10, Cliequot Club Eskimos, WEA; 10-11, Goodrich Silvertown Cord orchestra, WEA.

WTAM, Cleveland, Ohio (389.4m-760ke), 6-7 p. m., Hotel Hollender orchestra.

WVIC, Hartford, Conn. (475.9m-630ke), 6:50 p. m., Hotel Bond trio.

WVH, Detroit, Mich. (352.7m-850ke), 9:30 a. m., "Tonight's dinner"; 12:05, Jules Klein's Hotel Statler orchestra; 3, Detroit News orchestra; 6, dinner concert; 8, concert, WEA.

Central Time Stations

CKY, Winnipeg, Can. (384.4m-780ke), 10 p. m., dance program, Cliff Menzies and his colleagues.

KFKX, Hastings, Neb. (288.3m-1040ke), 5:30 p. m., dinner concert relay, KDKA; 7:30, musical program.

KFNF, Shenandoah, Ia. (263m-1140ke), 7 p. m., old-time fiddling, Dearborn, Mo., Ed. Sanders, director.

KMOX, St. Louis, Mo. (280.2m-1070ke), 12:30 p. m., organ recital, Arthur L. Utt; 3, string ensemble music with soloists; Mrs. James Burgin, violinist; 4, string ensemble music with soloists.

KOL, Gulf Bluffs, Ia. (278m-1080ke), 6:30 p. m., Art, Matt's Imperf, dance orchestra; regular dinner program; 7:30, Sleepy Time Girl, Bernice Cizho, conductor; 7:50, program, The Omaha Conservatory of Music; 11, hotsy-totsy hour; Al Keese and his Broadway orchestra.

KPRC, Houston, Tex. (296.9m-1010ke), 12 noon, Optimists' club luncheon program, Jerry Mitchell, president; 5:30 p. m., Uncle Judd's kiddies' hour; 7:30, Flanchard's dance orchestra; 8:30, Aeolian string quartet, Cedric Seaver, conductor; 9, Mr. and Mrs. H. T. Huffmaster, baritone and dramatic soprano.

KSD, St. Louis, Mo. (545.1m-550ke), 6:55 p. m., WEA chain; 7:30, Esmeralda Berry Mayes, pianist; 8, WEA chain.

KTHS, Hot Springs National Park, Ark. (374.6m-800ke), 9-9:15 p. m., Eastman hotel string quartet; 9:15-9:40, Spanish classics, Eastman Eight, Jack Lube, director; 9:45-10:15, New Arlington hotel dance orchestra, Lon Chassy, director; 10:15-10:45, piano specialties, Elmer Menard.

KWVG, Brownsville, Texas (278m-1080ke), 12 noon, music; 8:30 p. m., classical program; E. C. Toothman, baritone; Mrs. Harry Faulk; Juanita Bory and the Skipper; John Callahan, cornet solos; Mrs. Kowalski, pianist.

WCBD, Zion, Ill. (344.6m-870ke), 8 p. m., Mr. Barton, Mrs. Thomas; Mark Whiteside, baritone; Mrs. J. D. Thomas, soprano; M. P. Barton, tenor.

WCCO, Minneapolis-St. Paul, Minn. (416.4m-720ke), 12 m., concert, Donaldson's orchestra; 2, among the musicians, H. A. Bellows; 4, readers' club, Eleanor Poehler; 5:30, children's hour; 7, program, WEA, The Larkinites; 7:30, musical program; 8, program, WEA; 8-9, Cliequot Club Eskimos; 9-10, Goodrich Silvertown Cord orchestra; 10:20, dance program, Emmet Long's Golden Pheasant orchestra.

WDAF, Kansas City, Mo. (365.6m-820ke), 3:30-4:30 p. m., the Star's string orchestra; 6-7, the Tell-me-a-story-lady; The Triloon ensemble; 11:45-1, Ted

9-10, Silvertown Cord orchestra; 10-10:10, "Sam 'n' Henry"; Radio comic strip; 10:10-10:15, old-time favorite songs; 10:15-11, dance music; songs, Correll and Gosden; Freda Leonard and Jewel Barnett.

WGST, Atlanta, Ga. (270m-1110ke), 7-8 p. m., Mrs. Samuels L. Metcalf, mezzo-soprano.

WHAS, Louisville, Ky. (399.8m-750ke), 1-2 p. m., Benson trio; 3-3:30, Mrs. Myrtle Fulks Zahn, Jr., organist; 4-5, Music Box concert; 7:30-9, Zeta Chapter, Delta Omicron National Musical sorority, Angeline McCrocklin, director.

WHB, Kansas City, Mo. (365.6m-820ke), 7:50 p. m., dinner hour organ concert, Linwood theater; 8-9, Edith Gregg and her King Joy Low Syncopators; 9-10, string quartet.

WHO, Des Moines, Iowa. (526m-570ke), 7:30-8 p. m., Raleigh quintet; 8-9, Bankers Life trio; 11-12, Bankers Life Corn Sugar orchestra.

WIBO, Chicago, Ill. (226m-1330ke), 2-4 p. m., Shut-in program; Ted Florio, pianist; Dan Russo, violinist; Marie Tully, soprano; Wayne Meyers, reader; Hicky and Johnson, guitarists; Dorothy Davie Dillow, soprano; 6-8, dinner concert; songs made famous by John McCormack, Walter Preston; Helen Snyder, soprano; Harriet Eichel, contralto; William Molnaire, tenor; string trio; Chester Newman, baritone; Swedish pregram; 12 midnight, sambora; Ted Florio, pianist; Dan Russo, violinist; Marie Tully, soprano; Wayne Meyers, reader; Henry Davis; Erwin Cornelius, uke soloist; Jack Goodman.

WIJZ, Chicago, Ill. (322.4m-930ke), 10 p. m., "H. M. S. Pinafore," Zenith Opera company.

WJJD, Muncie, Ind. (370.2m-810ke), 12-1 p. m., Palmer house symphonic players; Palmer house trio; 2-3, Howard L. Peterson, organist; 4-5, music, children; daily assembly of 1250 children; 5:30-7, Jack Nelson; Palmer house symphonic players; Howard L. Peterson, organist; Palmer house studio; Palmer house Victorians; 12:30, Garod studio; Palmer house Victorians; Jack Nelson.

WKRC, Cincinnati, Ohio (422.3m-710ke), 10 p. m., Marion McKay and his orchestra; 11, popular song review, Bert Lindsey, Merrill Schwartz, Kern Alyward, Abe Farb; 11:15, Marion McKay and his orchestra.

WLIE, Chicago, Ill. (302.8m-990ke), 7-7:30 p. m., musical program; 7:30-8, Hires' Harvesters; 11-1 a. m., dance music; songs, Correll and Gosden. Hawaiian guitar music, Leonard Brothers.

WLS, Chicago, Ill. (344.6m-870ke), 6 p. m., WLS trio; 6:40, Ralph Emerson, organist; 7, lullaby time; 7:20, "Common Sense in Music," Dr. Spaeth.

WLW, Cincinnati, Ohio (422.3m-710ke), 7:30 a. m., healthful exercises, William Stradman, physical department Y. M. C. A.; 8, morning devotions, auspices of Parkway Y. M. C. A.; 12:05 p. m., organ concert, Mildred Frigge; 12:30, health talk, Dr. Carl A. Wilzbach, executive secretary Central Y. M. C. A.; 12:40, song, Russell (Red) Green, lyric tenor; 4, piano recital, Adelalde Apfel; 6-8:30, Jubilee class 1917, Scottish Rite reunion, hotel Gibson; 10, three minute message, U. S. Civil Service department; 10, popular concert, Doherty Melody Boys, dedicated to Crosey Jobbers in the state of Alabama; 11, the Mustcome male quartet; 11:15, popular dance music, Castle farm; 11:30, popular pianist, Clarence Berger; 12:15, Night Howls, Crosey Sky Teniers.

WMAQ, Chicago, Ill. (447.5m-670ke), 1 p. m., Advertising council; 2, shut-in program; 4, Illinois Federation of Women's clubs program; 4:45, pupils, Kindred Arts school; 5:15, Topsy Turp time; 6, Chicago theater program; 6:30, Hotel LaSalle orchestra; 9:20, program, Catherine Bly Utessh, director.

WMC, Memphis, Tenn. (499.7m-600ke), 8:45, p. m., Cortese ensemble.

WOAW, Omaha, Nebr. (526m-570ke), 12:45 p. m., Gilbert Jaffy and his Little symphony; 6, entertainment; 6:20, Nanna Kea trio; 6:50, Randall's Royal Fontenelle orchestra; 9, classical; 10:30, Herb Feierman and his Omadala orchestra; 12 midnight, night watchmen jubilee.

WOC, Davenport, Ia. (483.6m-620ke), 5:45-6 p. m., chimes; 7-7:30, Larkinites, WEA; 7:30-8, Plov Boys' quartet; 8-9, Cliequot Club Eskimos; 9-10, Goodrich Silvertown Cord orchestra; 11-12, LeClair Goodrich orchestra; Peter MacArthur, baritone.

WORD, Batavia, Ill. (275m-1090ke), 8 p. m., Webster hotel concert trio; 8:15, international Sunday school lesson; 8:30, recital, Cosmopolitan school of music.

WQJ, Chicago, Ill. (447.5m-670ke), 7-8 p. m., Boston store concert trio; Clement Laskowski, tenor; 10-1, Rainbo Skylarks; Jean Carlson, soprano; Sidney Schneider, whistler; Jerry Sullivan; Rose Vanderbosch, soprano; Hal Lanslog, uke soloist; Leo Butler, Giant of Radio Sidney Lachman, tenor; Bert Davis, Clown of the Air; Marie Pollitt; 1-2, Ginger hour.

WSAI, Cincinnati, Ohio (325.9m-920ke), 7 p. m., program; 7:30, Hires' Harvesters; 8, Cliequot Club Eskimos; 9, Silvertown Cord orchestra, Joseph Knecht, director.

WSB, Atlanta, Ga. (428.3m-700ke), 8 p. m., Allen Nicholson union; 10:45, Dr. Charles A. Sheldon, Jr., organist.

WSMB, New Orleans, La. (319m-940ke), 9:30-11:30 p. m., Owls orchestra, Radio Revelers' orchestra; Liberty theater.

WSTI, Iowa City, Ia. (483.6m-620ke), 12:30 p. m., Mrs. Preston C. Coast, organist.

Saturday, February 20		Monday, February 22		Tuesday, February 23		Wednesday, February 24		Thursday, February 25		Friday, February 26	
Eastern	Central	Mountain	Pacific	Eastern	Central	Mountain	Pacific	Eastern	Central	Mountain	Pacific
7:30 p. m.	6:30 p. m.	5:30 p. m.	4:30 p. m.	5:10 p. m.	4:10 p. m.	3:10 p. m.	2:10 p. m.	7:15 p. m.	6:15 p. m.	5:15 p. m.	4:15 p. m.
WHAR (275m-1090ke)	WLBZ (275m-1090ke)	WLBZ (275m-1090ke)	WLBZ (275m-1090ke)	WLBZ (275m-1090ke)	WLBZ (275m-1090ke)	WLBZ (275m-1090ke)	WLBZ (275m-1090ke)	WLBZ (275m-1090ke)	WLBZ (275m-1090ke)	WLBZ (275m-1090ke)	WLBZ (275m-1090ke)
7:45 p. m.	6:45 p. m.	5:45 p. m.	4:45 p. m.	5:10 p. m.	4:10 p. m.	3:10 p. m.	2:10 p. m.	7:15 p. m.	6:15 p. m.	5:15 p. m.	4:15 p. m.
WTAQ (268m-1200ke)	WTAQ (268m-1200ke)	WTAQ (268m-1200ke)	WTAQ (268m-1200ke)	WTAQ (268m-1200ke)	WTAQ (268m-1200ke)	WTAQ (268m-1200ke)	WTAQ (268m-1200ke)	WTAQ (268m-1200ke)	WTAQ (268m-1200ke)	WTAQ (268m-1200ke)	WTAQ (268m-1200ke)
7:50 p. m.	6:50 p. m.	5:50 p. m.	4:50 p. m.	5:10 p. m.	4:10 p. m.	3:10 p. m.	2:10 p. m.	7:15 p. m.	6:15 p. m.	5:15 p. m.	4:15 p. m.
WLBZ (275m-1090ke)	WLBZ (275m-1090ke)	WLBZ (275m-1090ke)	WLBZ (275m-1090ke)	WLBZ (275m-1090ke)	WLBZ (275m-1090ke)	WLBZ (275m-1090ke)	WLBZ (275m-1090ke)	WLBZ (275m-1090ke)	WLBZ (275m-1090ke)	WLBZ (275m-1090ke)	WLBZ (275m-1090ke)
8:00 p. m.	7:00 p. m.	6:00 p. m.	5:00 p. m.	6:50 p. m.	5:50 p. m.	4:50 p. m.	3:50 p. m.	8:00 p. m.	7:00 p. m.	6:00 p. m.	5:00 p. m.
WLBZ (275m-1090ke)	WLBZ (275m-1090ke)	WLBZ (275m-1090ke)	WLBZ (275m-1090ke)	WLBZ (275m-1090ke)	WLBZ (275m-1090ke)	WLBZ (275m-1090ke)	WLBZ (275m-1090ke)	WLBZ (275m-1090ke)	WLBZ (275m-1090ke)	WLBZ (275m-1090ke)	WLBZ (275m-1090ke)
8:10 p. m.	7:10 p. m.	6:10 p. m.	5:10 p. m.	6:50 p. m.	5:50 p. m.	4:50 p. m.	3:50 p. m.	8:10 p. m.	7:10 p. m.	6:10 p. m.	5:10 p. m.
WLBZ (275m-1090ke)	WLBZ (275m-1090ke)	WLBZ (275m-1090ke)	WLBZ (275m-1090ke)	WLBZ (275m-1090ke)	WLBZ (275m-1090ke)	WLBZ (275m-1090ke)	WLBZ (275m-1090ke)	WLBZ (275m-1090ke)	WLBZ (275m-1090ke)	WLBZ (275m-1090ke)	WLBZ (275m-1090ke)

KYW, Chicago, Ill. (535.4m-560ke), 12:05 p. m., Congress hotel orchestra; I, luncheon concert; 2:35-4, afternoon frolic; 6, dinner music, KDKA; 8:20, musical program; 9, an hour of music; 10-11:30, evening at home; 1-2, insomnia club.

WBAP, Fort Worth, Tex. (475.9m-630ke), 12:05-12:30 p. m., Ward's Trail Blazers; 6-6:30, Chief Gonzales, Texas Hotel Royals; 7:30-8:30, Fort Worth Harmony club; 9:30-11, American Institute of Banking; 11-12, Pantages theater.

WBBM, Chicago, Ill. (226m-1330ke), 4-8 p. m., Sandy and Harry; Valentino Inn orchestra; William Dalton, baritone; Irene Beasley; Sidney Nireman; Russell Meyers; Jack Pennell and Freddy Palmer; 8-10, Ziegler sisters; Moulou Brenner orchestra; Two Jays; Charlie Garland; Brewers' Zig Zag trio; Maurie Silverman; Pauline Sullifer; Alass, violinist; Floyd Falch; 10-12, Harry and Sandy; Moulou Rouge orchestra; Harry Bratsford, mandolin; Pearl Jarret, pianologous; Fred Jacobson; Moulou Rouge cafe stars.

WCAL, Northfield, Minn. (336.9m-890ke), 9 p. m., program, Norwegian Lutheran church.

Weem's Victor Recording orchestra; Ted Meyn, organist; Billy Adair's orchestra.

WEBB, Chicago, Ill. (370.2m-810ke), 7 p. m., Oriole orchestra; 8, special recital; 9, Oriole orchestra; 9:45, Belle Forbes Cutler, soprano; Ruth Buhl Flicke, contralto; soprano; Ruth Buhl Flicke, reader; Rita McFawn, Mary Bieber.

WGES, Chicago, Ill. (250m-1200ke), 5-7 p. m., pipe organ, piano, bass and tenor solos; 8-9, orchestra, vocal, pipe organ selections; one-act playlet; 11-1 a. m., Coyne Srenaders, artists, features.

WGN, Chicago, Ill. (302.8m-990ke), 10-10:15 a. m., good health period; 10:15-10:45, entertainment for shut-ins; 11-11:30, morning organ concert, Chicago theater; Dean Seabury; 12:01-12:30 p. m., noon hour entertainment for children; 12:40-2:30, luncheon concert music; 2:30-3, Lyon & Healy artist recital; 3:25, Port of Missing Men; 3:30-4:15, tea time music; 4:30-5, organ recital, Edward Benedict; 5:30-5:57, Skeezix time; 6:30-6:45, dinner concert music; 6:45-7, old-time favorite songs; 8-9, Cliequot Club Eskimos;

ORIENTAL PROGRAM FRIDAY AT WFI

Thursday, February 25

program, H. L. Crockett featuring Ilya Bronson, concert cellist; 8-9, program, Willys Overland dealers; 9-10, KNX feature program; 10-11, dance music; 11-12, Ray West's Coconut Grove dance orchestra from Ambassador hotel.

Friday, February 26

Headliners Today

Table listing radio stations and their programs for Thursday, February 25. Columns include station call letters, time, and program title.

Friday, silent night for: CFAC, CHIC, CKNC, CKY, CNRC, CNRM, CNRO, CNRR, CNRW, KFAU, KFEQ, KFKU, KFMQ, KFWA, KFXF, KGO, KFAU, KLDL, KPRC, KUOM, PWX, WBBR, WCAD, WCBW, WEAQ, WEBW, WGBS, WGST, WHAZ, WIP, WJAZ, WKRC, WLW, WLWL, WNAD, WRC, WREG, WRVA, WSAI, WSUI, WSMB, WTAM.

Eastern Time Stations

CRNA, Moncton, Can. (291.1m-1030kc), 8 p. m., studio concert; 9, concert; 10:05, Teaberry time. WAHG, Richmond Hill, N. Y. (315.6m-950kc), 12:03 p. m., Sidney Raphael, pianist; Max Polansky, violinist; 7:30, Professor Richard E. Mayne; 7:45, Cecile LaBlanche, pianist; 8:15, organ recital direct from studio of Skinner Organ Company, New York City; Henry Rogers, organist; 9:00, Walter Leary, baritone; 9:15, Jimmy Smith, basso king; 9:30, Henrietta Mastin, soprano; 10:05, popular program; 10:20, Bernice Fletcher's orchestra.

GENERAL TALKS AND SPEECHES

Main table of radio programs for Friday, February 26. Columns include day, station, time, and program title. Includes sections for Saturday, February 20, Wednesday, February 24, Monday, February 22, Tuesday, February 23, and Thursday, February 25.

WGY players; 10:30, old-time dances, WGY orchestra. WHAR, Atlantic City, N. J. (275m-1090kc), 2 p. m., Seaside hotel trio; 7:30 talk; 8, trio. WJAX, Jacksonville, Fla. (336.9m-890kc), 3:30 p. m., Hemming Park band concert, Vessella's band, Oreste Vessella, conductor; 7:30, music memory contest; 8-10, popular program.

Central Time Stations

KPRC, Houston, Tex. (296.9m-1010kc), 12 noon, Frank Tilton, boy pianist. KWWG, Brownsville, Texas (278m-1080kc), 12 noon, orchestra music; 6 p. m., Roy Garcia, violinist. KYW, Chicago, Ill. (535.4m-560kc), 12:05-1 p. m., concert; 1, Joska DeBabary and his orchestra; Coon-Sanders orchestra; 6-7, dinner music, KDKA; 9, an hour of music 10-12:30, revue, Paul Ash and his orchestra; Coon-Sanders orchestra; 1, Insondia club.

Radio Digest

Illustrated

Reg. U. S. Pat. Off. & Dom. of Canada

Published by the
RADIO DIGEST PUBLISHING CO.,
(Incorporated)
510 North Dearborn Street
Chicago, Illinois

Telephones: Superior 7323, 7324, 7325, 7326, 7327

E. C. RAYNER, Publisher

Eastern Office, Park-Lexington Building, 247 Park Ave.,
New York. Telephones: Ashland, 8144, 8145, 8146

Member of the Audit Bureau of Circulations

241
PUBLISHED WEEKLY

SUBSCRIPTION RATES

Yearly in U. S. and Possessions and Canada, \$5.00
Foreign postage, \$1.00 additional. Single copies, 10 cents.

Vol. XVI Saturday, February 20, 1926 No. 7

Elect Radio Congressmen

WE WERE glancing over a copy of "Rhodes Colossus" the other day. It is only a little house organ—a means of conveying the ideas and opinions of a business organization—but it is one of the best edited in America. In the issue there appeared an article relating to the great Imperial Valley of Southern California. The editor in his article recounted an interesting story which has its Radio application.

The great Imperial Valley was threatened some years ago when the Colorado overflowed its banks and ran wild for almost a year, causing great destruction of property. The government could not stop the overflow. Finally President Roosevelt called Harriman, the railroad king, since deceased, and requested, "Use the full facilities of the Southern Pacific to stop the gap—I will see you are paid."

For months the railroad dumped 100 cars of rock a day into this gap and finally the Imperial Valley was saved.

Did congress pay the railroad? Not a red cent. Yet, we criticize the railroads! If you want to see samples of the rankest injustice, try to get a bill through congress in which the members cannot see votes, or an issue for their political selves. Roosevelt tried his best to make good, but the boys on the other end of Pennsylvania avenue needed all the cash for their constituents.

The narrative concluded is just a typical demonstration of congress.

What connection does it have with Radio, you ask. As a matter of fact the story has several direct applications to congress and Radio affairs now before our august body of lawmakers.

The senate is now engaged, or it was as we went to press, in a terrific ordeal. All the senators are trying to find out how they should vote on the World Court. The lavishly expensive Bok lobbies and enticing social affairs of the foreign embassies, coupled with some of the votes of their constituents, are allied for the court. The interests in favor of pursuing the famous Monroe Doctrine, backed by other constituents, are allied against the court. It is terrible to be a senator and not know how to vote so as to please friends as well as the voters and insure one's reelection.

The house is busy with the tax bill. The congressmen must "ride the fence" until they learn how many votes "so-and-so" controls and what is desired by him.

And so Radio broadcasting, in which we must admit not everyone is interested, must be shoved aside by our congress to give right-of-way to the more general and vote-deciding questions.

We hate to be pessimistic, but we wonder if congress will ever pass a new Radio law? We wonder if congress and the budget bureau will ever give the Radio development branch (bureau of standards) and the Radio administrative branch (inspection force etc.) enough money to make broadcast transmission and reception what it SHOULD be?

You, John Smith, and you, Mary Brown—do you ever get your representative in the corner and ask him just what he is going to do for Radio? Do YOU bind him to that promise with your vote?

If you can't do anything with the men who are now sitting there on the hill in Washington, your representatives, get busy and put in new men whom you can TRUST to carry out your orders.

WIR Investigates Trouble

INTERFERENCE from WIR, Radio Corporation of America short-wave telegraph station at New Brunswick, N. J., may cease. The company says it is making changes to stop this interference. We will be glad to compliment this organization for its cooperation—once the interference has ceased.

In this connection, allow us to remark, that at KDKA, the Westinghouse station at East Pittsburgh, 20,000 watts of power are sent by a similar short-wave telegraph transmitter. This outfit causes no speakable interference. No complaints have been received, even from Pittsburgh.

Perhaps the Westinghouse engineers could show WIR how to do it?

RADIO INDI-GEST

Yes Sir, She's My Baby

The idea has occurred to me
That without undue activity
On the part of my anatomy
That's commonly known as brain.
I could possibly write a verse or so
Concerning the songs on my Radio—
There won't be any sense to it though,
So it won't be much of a strain.

THAT CERTAIN PARTY, OH BOY, WHAT A GIRL
Once told me, "I'M ALL FOR YOU?
THEN I'LL BE HAPPY." I said, "SUGAR PLUM
But BROWN EYES, WHY ARE YOU BLUE?
I'M SITTING ON TOP OF THE WORLD, right now,
Together through life we'll roam."
"SWEET MAN, I'm AFRAID, I'm TOO TIRED,"
she said,
"SHOW ME THE WAY TO GO HOME."

Now PADDELIN' MADELINE HOME, ALL
ALONE,
BY THE LIGHT OF THE STARS isn't fun,
'Cause she lives 'way DOWN BY THE WINIGAR
WOIKS.
But when she said, "WONDERFUL ONE,
I'm THE BOOTLEGGER'S DAUGHTER, come on
in the house,"
I felt FUNNY all over, I vow,
For I thought all along she was ANGRY, you see—
I tell you, YOU GOT TO KNOW HOW.
MARSHALL HYDE

Lese Majesty!

Dear Indi: Won't you tell me who the Night Herd is?
I like his poetry as it is a lot like Edgar Allen Poe's.
Both of them have so much illiteration.
MARJORIE

Marjorie, we ask you, "Is that nice?" Now that you
have had time to think it over, aren't you a little sorry?
They both seem like such nice boys. We hope this is a
typical graphic error.

Can't Confirm

The other night while tuning in,
I heard the loudest thund'ring din,
The loop got hot, the tubes most choked,
The dials got red, the speaker smoked.
Just where it was, I cannot tell—
But I think it was Aich E Ell Ell.
RAY D'O

Hey Keeper! Check Up the Inmates

Dear Indi: Please confirm this foreign reception.
Sunday night: Heard someone saying, "Duck your
head, too low." This must have been 2-LO. Noticed
room getting dark and found fog coming from loud
speaker. Sure it was London and the whistles and
squeals were fog horns. Monday night, about 10:15
p. m.: Noticed very peculiar odor. Thought I must have
short circuit so I opened cabinet and low and behold!,
in place of the third tube I found a big schooner of
lager beer with foam and everything. Found limberger
sandwich stuck in speaker and I think I had Hamburg.
C. A. SHOOP

We think you had 2-DT's. But, anyway, there may be
something to it. Just one question: What kind of a
set did you use Monday night?

Those Foreign Stations

Sets are squealing—and I'm feeling—
Like I'd wish to kick them out.
Tubes are howling—sounds like prowling
Tomcats in the dead of night.
Silence falling—no voice calling—
Expectations fill the air.
I am wishing—and I'm fishing—
For those foreign stations there.

Time is drifting—shadows shifting—
And our patience's drifting too.
Dials adjusting—and you're fussing—
Start to feel a little blue.
Silence shattered—voices clattered!—
"Whoops!—I've got a foreign nation."
Like to trounce him—for announcin'—
Just a Sacramento station.
ANNIE LOU

The Rum Fleet Sails On It

Proof of Corkscrew Wave Is Offered

—Columbus (Ohio) Dispatch—Radio page.

We Were Lead Into This—He Dared Us

Policeman sings over Radio, making big hit.—News
note.
The "copper" who protects us from those who "steal"
and who has "iron" nerves and wears "brass" buttons
on his uniform, sang with a voice of "gold," and even
though there were "silver" threads in his hair, he
proved to be of good "mettle" and was worth many
"nickels" to hear.

News of the Week

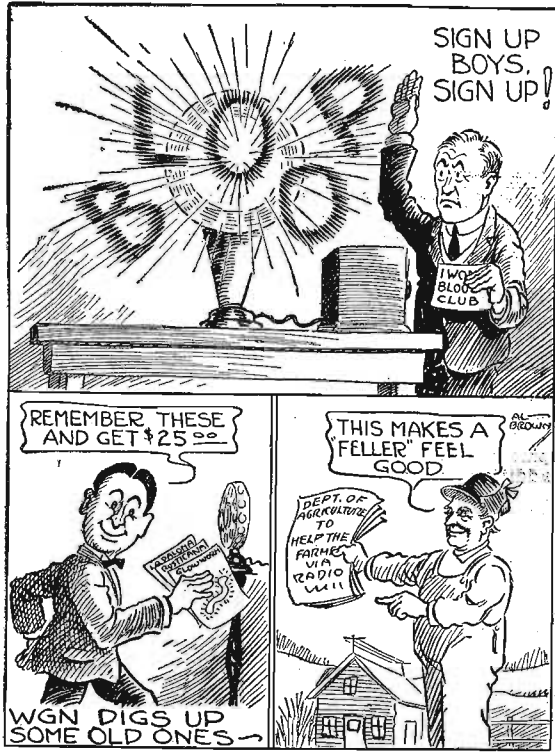

Condensed

BY DIELECTRIC

Wouldn't it have been more interesting if, during International Test week, some American stations had remained on the air to make the feat of receiving Europe a little harder? We had such ease in picking up Brussels, Aberdeen, London, Paris, Berlin and Barcelona that a mere South American station barely interested! What great good fortune every Radio fan experienced this year with the total absence of "squeelers," so annoying heretofore. Personally, there will be no thrill in another such program for these reasons: the millenium is not so near but that the millions of "squeelers" would repeat their orgy; commercial code operators will still have their messages for lady friends on ship and shore, with no time like a silent period to get it across; Old Man Static is no respecter of seasons; American jazz sounds as well here as abroad.

In November, 1924, I made mention in these columns of a feature broadcast from Station WJZ, in which Lieutenant Smythe of Toronto, Can., reviewed his experiences in a canoe traveling from Nova Scotia to New York. The other night we heard the rest of his story from Station WAHG, the Grebe station at Richmond Hill, N. Y. Such a tale of adventure must appeal to many listeners, particularly when depicting serious handicaps to canoeing across the English channel, and further, in his journey to Rome. These personal contacts with men and women of varied interests add greatly to the lure of listening in. It might be extended.

If reports of reception in Moscow of American music be true, then it is possible that a concert by the United States Marine band orchestra was heard by some of our distant fans. I wish it could be arranged to have this organization appear on the air at a time when most of the world could listen to them. Every American takes just pride in their work and would like other nationals to know their excellence.

From the broadcasting station of the Lutheran Theological seminary in St. Louis, Station KFUO, listeners had the opportunity of hearing addresses on an identic theme rendered in several languages. The novelty of that experience may not have been so great, but in any case, the import was of far greater significance. For Christian nations not only, but non-Christian (where they were in tune with this station), heard a great and vital subject presented so millions could understand. It was the real awe-inspiring moment of the entire week's broadcasting.

Maybe some of you have been checking up on me as to the number of references made here to the Formica orchestra, if so, add another. The program being mentioned conformed neither to strictly classical nor popular music. Instead it trod a middle-of-the-road course choosing the lighter numbers from the former and eschewing the vulgar in the latter.

When the midnight hour arrives it seems to be a signal for revelry, sponsored by studio directors and shared by Radio audiences. To what extent listeners indulge in a frolic while tuned to these programs only they can tell. Certainly everyone in the studio of WMC, Memphis, at the time of a recent midnight frolic was having a glorious good time singing lively songs and entering into the spirit of an orchestra swinging through one dance number after another. It was noticed that several of the singers had pleasing voices.

ABC Radio Fundamentals for Everybody

Chapter VII—Radio Frequency Amplification

By Milo Gurney

FOLLOWING last week's article, in which the operation or functioning of the grid element of the vacuum tube was explained, it should be borne in mind that, under fair conditions, which would include a reasonable proximity to a broadcasting station, additional tubes are not required, nor additions to the circuit shown needed, in order to receive very satisfactory reception through head telephones. If, however, one is interested in having reproduction from a loud speaker, it is then necessary that some form of audio frequency amplifying equipment be added to the receiver. Such an addition is to function only to increase the volume of the rectified current as delivered from the detector. In addition to the above, if one is desirous of extending the distance from which signals are desired, it is then obvious that a means must be employed which will boost the intensity of the signal as received by the antenna to a value of sufficient magnitude to actuate the detector, and such boosting must precede, rather than follow, the detector. In effect, then, we have only to decide whether it is the radio frequency or audio frequency values, or both, which we desire to amplify in order to increase either or both of the desired values.

Three Popular Methods

It will be assumed in this article that the readers are most interested, not only in the functioning of audio frequency additions to the detector circuit, but also as to the relative merits of the several systems now offered to the purchaser, who is becoming more critical, as well as better informed.

Two methods of audio frequency amplification appear dominant this season in the appeals for popularity, one known as transformer coupling, the other as resistance coupling, while a third, which is termed impedance or choke coil coupling, is also making good progress in its struggle for recognition.

Of the three systems, transformer coupled amplification is the more generally used at present, it having gotten off to a generous start, before the other methods, and securing the greatest amount of attention from manufacturers. The circuit used for two stages of such amplification is shown in figure 19 as coupled to the output of a detector. The transformers used comprise two windings, each insulated from the other, of very fine copper wire. One of these windings, as shown at P-1 and P-2 in figure 19 is termed the primary, and is connected with P-1 to the plate output of the detector tube, while the P-2 terminal of this winding is connected to the positive terminal of a B battery supply. The associated, or second winding of the transformer, as shown in figure 19 as G and minus F, is connected with the G terminal to the grid terminal of the next tube in line, while the minus F terminal is connected to the minus F terminal of this tube's socket. To this is also connected the minus terminal of the A or storage battery used to heat the filament. In actual practice, the primary winding is placed within the central opening of the secondary winding, and well insulated from it. The two windings are then placed upon one leg of a laminated metal core, which not only acts as a support for the coils but also functions toward increasing the transfer energy value of the transformer. The total transformer thus assembled is housed in a suitable case to protect the windings from injury, and to make it presentable for sale.

Function of Transformer

Without entering into a discussion, which would be uninteresting, regarding the electrical factors involved, the function of such a transformer is to accept the audio frequencies as passed to it by the detector tube, and transfer these frequencies, without change, to the secondary winding, which passes them on to the next tube in line for further amplification. In doing so, as there is no physical connection between the primary and secondary, the transfer is made inductively. The inductive transfer of energy follows a well-known law in electricity. If two windings or coils are placed in close proximity to each other, and certain electrical conditions maintained, which permit of the current flow being transferred in the right direction, then as one coil is traversed by a current passing through it, there will be induced in the coil associated with it a current identical with that passing through the first coil. Of further interest is the statement that the two coils are designed to step up the voltage or pressure with as high as a six, and sometimes ten, to one ratio.

The current is then passed into the next

tube where, in place of acting as a detector, the tube is caused to act as an amplifier and raises the detected energy.

Two such stages are usually capable of delivering all the power which a standard loud speaker can handle, while it is also true that frequently two such stages bring to the last or output tube relatively more than the capacity of the tube. Transformer amplification has much to commend it, its chief asset being that but two additional tubes are

required, most other systems requiring three in order to secure an equal volume. Opposed to its use is the fact that at the present state of the art, it has not been possible to so design these transformers that they will amplify with equal clarity and volume the total voice band which is broadcast. This results in a muffling or, at times, the total elimination of either the extreme low notes or the equally extreme high notes received in music. Intensive engineering research

has, however, made a considerable advance in this respect, so that the market affords several transformers which are very acceptable.

Amplification Advancing

Resistance interstage coupling for the securing of audio frequency amplification has, during the past year, forged steadily ahead until it now easily holds second place with the Radio fraternity, as

(Continued on page 24)

Radiotone Loud Speaker

Now Only \$19.95
Was \$25.00

The BEST
Radio Affords

\$1.00
down!



Yes, Genuine Radiotone loud speaker—the same loud speaker that is selling everywhere for \$25.00—now at a sweeping cut price, only \$19.95 and on easy monthly payments, besides! Only \$1.00 with the coupon below brings the Radiotone to your home on approval for 30 days! No radio is complete without a loud speaker—a good loud speaker. The whole family may "listen in" at the same time, leisurely—instead of taking turns at the headphones. Or if you have a loud speaker now that isn't satisfactory, that doesn't bring in stations loud and clear, this is your opportunity to get a first class loud speaker—yes, the best and we'll prove it on this offer—at an astounding rock-bottom reduced price, direct—and on easy, monthly payments besides!

Makes Your Radio Complete

The Radiotone is the last word in sound reproduction and amplification for radio sets. It is super-sensitive. Brings in distant stations with full volume so every one in the room can hear distinctly and easily. Wonderful clearness and absolute purity of tone. No distortion. No crouching in front of the loud speaker to hear announcements.

The Radiotone has a 14-inch horn made of Thorite in one piece without seam or joint, acoustically correct. This eliminates the metallic clang you often hear in other loud speakers. The reproducing unit is entirely enclosed at the base of the horn. The well balanced construction does away with all vibrations. The Radiotone has a graceful shape with a beautiful black florduline finish. It stands 23 inches high and weighs only 15 lbs. No extra batteries needed for the Radiotone—just plug it in as you do your head set. Nothing to wear out or get out of order. Sent complete with cord and plug.

30 Days Trial!

When the Radiotone comes, there's nothing to pay. Use it freely at our risk, on trial for 30 days. See how much more use and fun, you and all the family get from your radio with this loud speaker. See how loud, clear and distinct the Radiotone brings in all stations—better than any other loud speaker you've ever heard, giving you the best that is in your set. After 30 days trial if you think you can get along without the Radiotone, return it to us and we will refund your dollar plus all transportation charges. No red tape. The trial costs you not a cent.

Straus & Schram, Dept. R-9912 Chicago, Ill.

Enclosed find \$1. Ship special advertised Radiotone Loud Speaker, I am to have 30 days free trial. If I keep the Radiotone, I will pay you \$3.00 monthly, total reduced price, \$19.95. The Radiotone is to become my property as soon as you receive the final payment. If not satisfied, I am to return it within 30 days and you are to refund my money and any express charges I paid.

Radiotone Loud Speaker No. Y8728A—\$19.95

My Name _____
(Head of the family must sign this order. If you are not of age, have your parent or guardian order for you.)

My Street Address _____
R. F. D. or Box No. _____

My Post Office _____ My State _____

My Shipping Point _____ I have lived in this Town _____ years

And before that I lived in _____ for _____ years
Town State

Occupation is _____ Age _____ Married _____
or Single _____

Give names of merchants who know you personally

Name _____ Town _____ State _____

Name _____ Town _____ State _____

If you have ever bought goods on credit by mail, tell us from whom. If there is anything else you wish to tell us about yourself, write on a piece of paper and enclose it with this coupon. But the coupon alone, fully filled out, ought to do. That's all we want to know and we're ready to ship the goods at once. No formalities. No C.O.D. We trust rich and poor alike when they merely show us that they are honest.

\$3.00 a Month

But if you decide to keep the Radiotone, pay only \$3.00 a month until you have paid the special reduced price—only \$19.95. See if you can equal this offer anywhere on such amazingly liberal terms. You'll scarcely feel those small monthly payments. Surely, now, you can afford to have the Radiotone—the best loud speaker—and get the most fun out of your radio set for all the family.

Send Coupon NOW!

Seize this opportunity on this special offer. Only \$1.00 with the coupon brings the Radiotone on 30 days' trial, satisfaction guaranteed, your dollar refunded if not satisfied. Send the coupon now while this special offer lasts.

Straus & Schram
Dept. R-9912 Chicago, Illinois

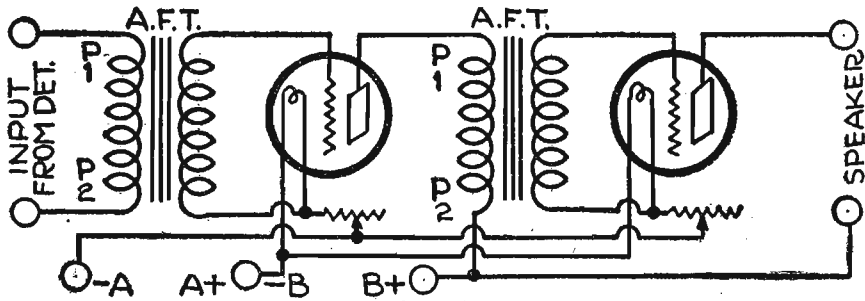

Figure 19

ABC'S OF RADIO SETS

(Continued from page 23)

much of the objections created through misunderstanding of its operative characteristics have been removed.

Resistance coupled audio amplification possesses as its dominant feature the ability to reproduce without distortion the voice or music as broadcast, which is, of itself, a result which all desire. The objection to its use has been that its amplification per stage is only that of the tube, and without any step-up ratio.

derstood, was that the current consumed per stage was less than in other forms.

In actual practice a resistance coupled amplifier consists of but fixed condensers as a means of transferring the fluctuating current from tube to tube, with a resistance of a predetermined value in both the plate to filament and grid to filament circuits, which act as controls to regulate the varying grid action. These values are somewhat critical for very best results but these have been worked out to practical form by the manufacturers of such devices so that

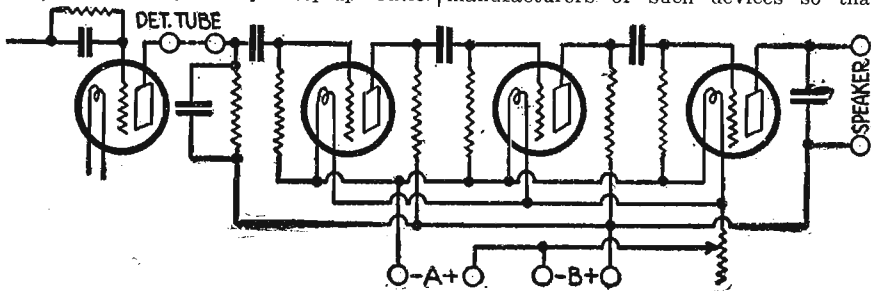

Figure 20

Therefore, in order to secure a volume equal to that of transformer coupling, it is necessary that three stages be used as against two in transformer work, or the use of an additional tube. As tubes are reaching lower price levels, the interest in this form of amplification has increased to the point where it is securing much deserved attention. Another objection which manufacturers of resistance coupling had to live down was the mistaken idea, of the Radio fan, that the B battery drain was excessive. It is true that it requires a higher B battery voltage in order to force the current through the resistances to the plates of the tubes, but that which was not un-

success is assured the amateur constructor.

Of late, those manufacturers interested in furthering this type of amplification have sensed the need of supplying tubes whose value as amplifiers of audio frequency current is greater than that found in the ordinary tubes, with the result that one maker has gone so far as not only to market high amplification tubes for the first two resistance coupled stages but has also placed a power tube on the market for the third stage.

(The different types of batteries used in Radio work and how to care for them will be next week's topic.—Editor's Note.)

"VOICE OF PORTO RICO"

(Continued from page 7)

In general WKAQ is broadcasting at present, Tuesday, 9 to 10:30 p. m. from the studio; Wednesday, 8 to 9:30 p. m. band concerts from the Plaza Baldorioty de Castro, and Tuesday, 8:30 to 10 p. m. from Cafe "La Cafetera" (The Coffee Pot). All this schedule is Porto Rico time, which is one hour later than E. S. T.

Even in summer, WKAQ is carrying so far that test concerts in September, 1924, were heard in Spain three consecutive nights.

Porto Rico "The Island of Enchantment in the Caribbean Sea" is now an established part of the Radio world. It had already joined the mainland by amateur Radio through the remarkably efficient efforts of the local division of the ARRL and stations like 4OI, 4SA and 4JE.

And now, just as our sister island Cuba, has carried the music and the spoken word of Cuba into our world wide common property, the ether, so WKAQ "introduced" Porto Rico to the broadcast listeners of both hemispheres.

vide first for the needs of our nearest neighbors in Iowa and surrounding states. We are glad if our service can be made available beyond the ocean and the national borders. We want everyone to keep posted on ideas that are new along the lines in which our people are especially interested. We want to live up to that slogan and "Keep Millions Advised."

Mr. May has an infectious way of bringing out good humor in those with whom he comes in contact in a personal way and also by his voice over the air. He is ably assisted by his wife, who is a graduate of the University of Nebraska and of the National Park Seminary of Maryland. She has specialized as a vocalist and sings for the KMA audiences, often in duet with Mrs. Henry Read. Mrs. May also helps to answer the many thousands of letters that come from Radio fans.

KMA broadcasts on a 252-meter wave length and is on the air daily except Sunday from 11:30 a. m. to 12:30 p. m.; 6 to 7 p. m. and 9 to 11 p. m.

WJAG BIRTHDAY PARTY

(Continued from page 5)

extended into other fields. Out in the sand hills the little farm house, cut off from contact with the world by far reaching roads, had its aerial and "home-made" receiving set. To the dwellers of this home, WJAG carried news of the produce markets, road conditions, affairs of the state and nation. It eliminated distance and brought scattered householders into a neighborly community.

Mr. Stefan inaugurated a telegraph school for amateur senders. Classes were organized in three states through the Norfolk station. By going down to the lower wave length, below the broadcast band, students were taught the codes. Many of these students have "graduated" and now have transmission sets of their own. Others have developed into licensed operators employed at stations scattered over the country.

Many listeners identify WJAG by the "Printer's Devil," a character introduced during the broadcast of a World's Series. Membership cards to the WJAG family bear a red imprint of his Majesty.

When you tune in on Mr. and Mrs. Salter's party you will know more about this mysterious personage. And you will find the family assembled on the 270 meter wave length, 12:15 p. m., February 20. Other characters to be met will be Old King Corn, Fricasee Chicken, Jack Spratt and wife and the "official constable."

KMA ADVISES MILLIONS

(Continued from page 6)

daily with an earnest endeavor to "Keep Millions Advised."

Among those to be heard regularly are the following:

The How-do-you-do Singers, Grady Fort and Doc Bellamy, known as the "Applesauce Twins—Brother Jonathan and Ben Davis;" Auntie Blossom (Mrs. Fort) and Miss Lavone Hamilton who appear Mondays and Fridays.

The Mandolin Orchestra, one of the first of its kind on the air.

Franham Trio, classical music.

Nixon's Dance Orchestra—music for home or party dancing.

June Case and Le Ona Teget—domestic science talks.

George Van Houtte, lecturer on world travels and horticulture.

Bob and Babe Riddle, junior entertainers who sing and clog dance.

Mary Stuart Nichols, "Miss Polyanna"—Children's hour.

William Howie, 15-year-old boy organist of First Presbyterian church.

Mayflower Trio, popular music interspersed with talks on flower gardening.

These are the regular entertainers and of course there are many others who are called for features, extras and specials.

"While we do reach out to the millions," said Mr. May, "our special aim is to pro-

Light to see— power to hear

WHEN you buy a Prest-O-Lite Storage "A" or "B" Battery for your set, you are not only saving money because they cost less, but you are buying radio batteries that are made by a company with over twenty years of manufacturing experience.

Prest-O-Lite Batteries were especially designed for radio in the world's largest electro-chemical laboratories. They deliver their rated Ampere hour capacities at full power, thus lengthening the time between recharging and assuring good reception.

Ask for Prest-O-Lite Radio Batteries. They may be purchased from \$4.75 up. It is no longer

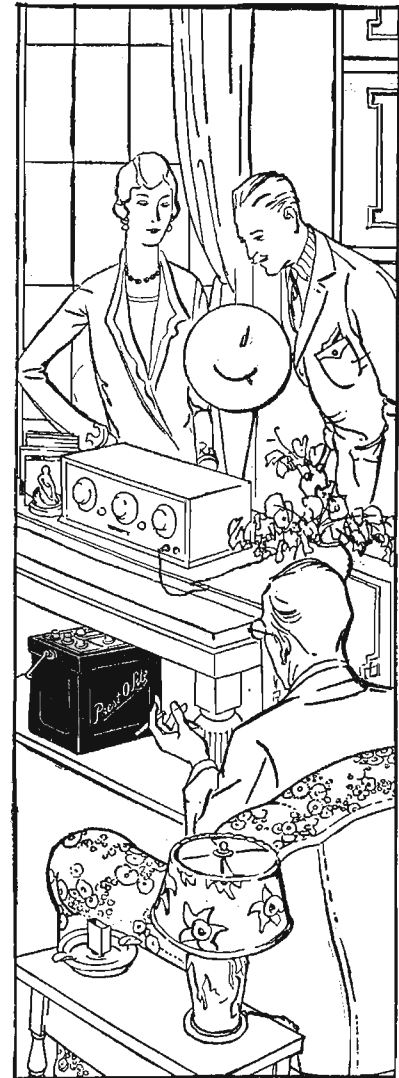

necessary to take a chance with batteries of unknown make. You will find Prest-O-Lite dealers within earshot of your own loud speaker.

THE PREST-O-LITE CO., INC.
INDIANAPOLIS, IND.
New York San Francisco
In Canada: Prest-O-Lite Company of Canada, Ltd.
Toronto, Ontario

Send for free booklet

"What every owner of a radio should know about storage batteries" is a little booklet which every radio fan will find interesting and helpful. It is crammed full of hints that will bring surprising radio results—and save you money. It's yours for the asking—without obligation.



Designed especially for radio

Prest-O-Lite
STORAGE BATTERIES FOR
MOTOR-CARS AND RADIO



How to Stop Blooping and Man-Made Static

Part II—How and Why Circuits Bloop

By the Technical Staff

THE PROBLEM of eliminating the squealing blooper set that interferes so much with other listeners for many miles around, took on a national aspect at the November Radio conference in Washington. Representation at the conference was composed of all prominent groups identified with the Radio industry, including manufacturers, broadcasters and listeners as well as engineers and mechanics, which gives the weight of national authority and desire to the resolution unanimously adopted at the conference to the effect that "the manufacture and sale of all radiating re-

1925, by Representative Wallace White of Maine, chairman of marine and fisheries, provides that: "There is hereby established a national Radio commission consisting of nine members who shall be appointed by the president (of the United States)" and that, "no person, firm, company or corporation shall use or operate any apparatus for the transmission of Radio energy or Radio communication or signals . . . within any state when the effects of such use extend beyond the borders of said state, or when interference is caused by such use or operation, with the transmission of such energy,

ence committee" of any local broadcast listeners' association to remedy or minimize it without the hearty cooperation of all broadcast listeners in the city who own and operate these devices. All that the officers, committees and members of such associations can do in such cases is to try to cooperate in all ways with the owners of radiating receivers, in their improvement and operation, so as to lessen and eliminate this troublesome and unpleasant form of interference. Associations of broadcast listeners have no quarrel with the operator of the radiating set, but desire his membership so that he can profit to the benefit of other listeners, through friendly instruction and cooperation in learning how to properly operate and improve both his receiver and his reception.

of the art, a tube receiver that would not cause at least a little interaction with another in the same city block.

Let's Study Circuits

This being the case, and Mr. Hoover's committee of the opinion that the Radio press might help, let's see what we can do. First of all, consider the pledge card which appears each week in Radio Digest. This week the blank appears on page 3. Fill it out, realizing just what it means, and send it in. True, there is no penalty if you do not live up to the pledge, but at least you have given your word to this

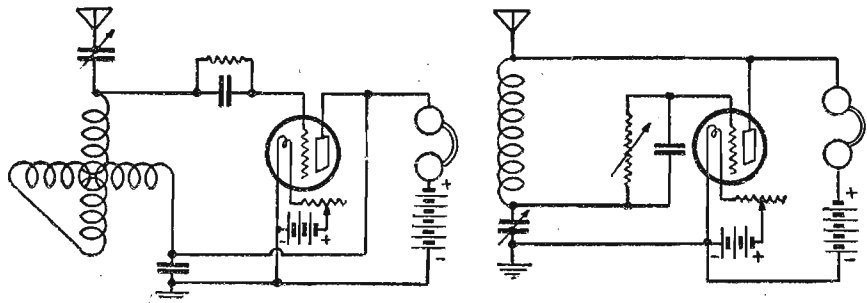

Figure 1

ceivers for broadcast reception should be discontinued at some definite and reasonable future date . . . in view of the fact that radiating receivers are potential sources of interference. If the manufacture and sale of such receivers be not discontinued within a reasonable period . . . legislation to that end shall be sought . . . because of the benefits which will accrue to the Radio public from the suppression of radiating receivers."

A bill "for the regulation of Radio communications and for other purposes" (H. R. 5589), is now pending in congress, the passage of which will have an effect on the future manufacture, sale and operation of radiating receivers. The bill, which was introduced in the national house of representatives on December 15,

communications or signals from within the state to any place beyond its borders or from any place beyond its borders to any place within the state or with the transmission or reception of such energy, communications or signals from or to places beyond the borders of said state."

A fine of "not more than \$500 for each and every such offense" is provided for violation of certain sections of the bill, and additional provision is made for "a fine of not more than \$5,000 and imprisonment for a term of not more than five years for each and every offense," in cases of more flagrant violations of various provisions of the bill not covered in the previously mentioned penalties.

While radiated interference from blooper sets is serious and widespread, it is beyond the ability of the "interfer-

Any progress in this direction will, however, depend upon the mental attitude of the listener himself, pending the eventual adoption of federal regulations or enactments that will compel the inconsiderate operator of a squealing blooper to give heed to the rights and pleasures of other listeners over a wide area. Mr. Herbert Hoover's fourth annual Radio conference, held in Washington on November 9, last year, adopted reports and resolutions in this language: "A large portion of all the interference reported in the various Radio districts has been due to radiating receivers, in the past," and further that "it is believed the dissemination of information upon this matter is of the greatest public importance, and that the attention of the press and of the periodicals of the country relating to Radio, should be especially called to it. One of the most effective means of eliminating such interference is to give publicity to methods of operating receivers in such a manner that they will not radiate." This last line might better have been altered to read "that radiation will be reduced to so small a value that interference can be caused only within a hundred feet or so of the receiver." It would be hard to imagine, at this stage

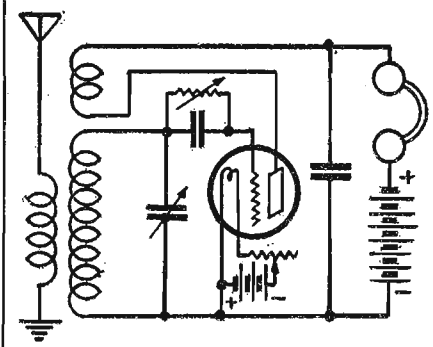

Figure 2

publication and the rest of the Radio listeners, that you will try to decrease or eliminate your own blooping. That being settled, we can go into a brief study of circuits as to why and how they bloop—merrily and devilishly.

In figure 1 we have the two worst offenders, the two most popular single circuit regenerative receivers. In both cases, there is an antenna circuit to be tuned to the wave length of the station, and an oscillatory circuit also tunable to the station. No more perfect transmitters could hardly be devised. The coupling of the oscillating circuits is as tight to the antenna circuit as it could be. The

(Continued on page 26)

Easy to trace circuits with a Belden Battery Cord

A BELDEN Radio Battery Cord has five flexible rubber-covered cotton-insulated conductors, each identified by a separate color marking. There is no danger of short-circuits between A and B-batteries that are so costly in tubes.

Another thing! The Belden Radio Battery Cord takes the place of the messy tangle of wires usually found between a radio set and the batteries. It makes a neat, compact installation that greatly improves the appearance of any set.

Look for the Belden Striped Carton

One burned out tube will pay for many Belden Radio Battery Cords. Why not get your cord, now?

Mail the Coupon for Free Illustrated Booklet

Belden

JEWELL

JEWELL CIRCULAR No. 739 → Describes this new 2-inch high resistance Voltmeter with special prods for plugging into the jacks on new Radiola, Victor and Brunswick sets.

Control of the filament voltage of tubes is very important.

JEWELL ELECTRICAL INSTRUMENT CO.
1650 Walnut St., Chicago
"26 Years Making Good Instruments"

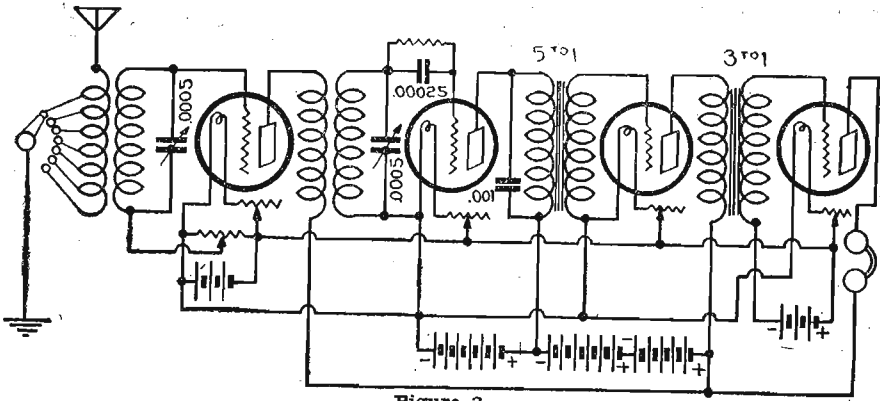

Figure 3

HELP STOP BLOPING

(Continued from page 25)

antenna circuit gets every atom of energy possible when the tube approaches or goes into oscillation. Worst of all, the control of regeneration is poor, and practically every time tuning is tried, the built up regeneration spills over into a state of out and out oscillation. When the last of these sets has gone to the "land of demolished receivers" a tremendous lot of bloping will be noticeably missing. Don't try to operate this type; you cannot get selectivity yourself and you make reception miserable for hundreds of others.

Correcting the Single Circuit

Now comes the correction for these types. If your means are limited, at least revamp your apparatus into the circuit of figure 2, which is still a potential blooper, but far less so than the first two shown. There are any number of good three circuit tuners on the market. Davenport Laboratories at Davenport, Iowa, make a good one. The Ambassador Sales company of New York have compact low loss types. The Uncle Sam baby tuner will go into just about the space your coil must have occupied in the other type. Your .0005 mfd. 23-plate condensers go into such a circuit perfectly.

If you are a little better fixed financially, it would be even better to add a stage of balanced radio frequency ahead of your present equipment. This will not only decrease or eliminate your radiating offenses but will materially increase your reception range. Complete instructions for building such a stage will be presented later in this series, in fact two or three types will be described. You can purchase one all made up under the name of Penetrola. On the other hand, if you have a set with the circuit of figure 2, and wish to both cut your bloping and increase your range, you can build one of these non-radiation stages to be described, or purchase one built along the lines of that mentioned. You would have a corking good receiver if a stage of balanced tuned radio frequency were added to the circuit of figure 2. It would be just about the equivalent of a Brown-Ing-Drake, Samson, Roberts, or Skeeters.

In figure 3 is shown a stage of unneutralized radio frequency which, for purposes of discussion, may be considered as any of the five tube outfits on the market in which oscillation is controlled by varying the R.F. filament brilliancy, varying the grid bias (as shown) or varying the plate potential with a 200,000-ohm resistor.

All three of these factors enter into a condition of oscillation. Let us say you have the single stage of R.F. adjusted to maximum regeneration, just below oscillation, or two stages for that matter. If the grid is made slightly more negative with the potentiometer, if the rheostat is turned to increase filament brilliancy, or, if the plate potential (voltage) is raised by cutting out a little resistance, the tube "spills over." Now we're all human; if we have a distant station very faintly, we want to try to get "just a little more" out of the set. And "bang" the old DX-getter spills over, and several hundred others, set to enjoy that program, hear an awful howl. A properly neutralized "neut," a well-built "RFL" set, or any of the correctly de-

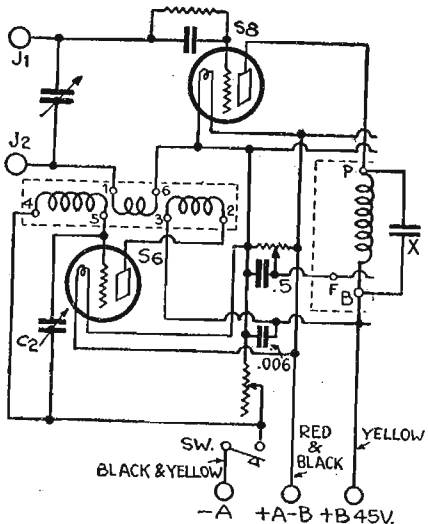

Figure 4

signed "bridges" such as Isofarad, will not quite go over, but few have such outfits.

The Tuned R.F. Remedy

Something has to be done to make it impossible to try to get "just that little bit more" and yet have efficiency. Now presumably you have from \$100 to \$250 tied up in that set of yours and you're not going to sell it at a loss just because you send out "a little squeal now and then." It will make another dial but you really should, in fairness to all concerned, put one of these "radiation preventers" in front of your set. Then if you want to

(Continued on page 30)

Photogravures of Your Favorite Artists GALLERY of RADIO STARS

Suitable for Framing or Placing in Your Album

BY SPECIAL arrangement, Radio Digest is able to offer its readers a great opportunity to secure fine photogravures of their favorite Radio stars at practically no cost.

Radio fans will be able now, by this very special offer, to have pictures of their favorite artists and announcers before them when they listen in.

All that is necessary to secure photogravures from the Gallery of Radio Stars is to send the coupon published each week in Radio Digest, accompanied by ten cents to cover the cost of mailing and postage. Where a series of three photogravures is desired, it will only be necessary to send twenty-five cents and three consecutively numbered coupons clipped from Radio Digest. Remittance must accompany the coupon. Cash at your risk. Add 5 cents to personal checks for exchange.

WITH COUPONS **Only 10c Each -- 3 for 25c** To cover cost of mailing and postage



Size Eleven by Fourteen Inches

Select Your Favorites from the Gallery of Radio Stars

- | | |
|--|--|
| 1 Wendell Hall, king of ukulele ditties | 26 Correll and Gosden of "Kinky Kids Parade" fame, at WEBB and other stations. |
| 2 Graham McNamee, 1925 Gold Cup announcer | 27 Norman Brokenshire, popular at WRC, WJZ |
| 3 Jack Little, popular wandering balladist | 28 Indiana Male Quartet, popular at WEBB |
| 4 Paul Small, who won fame through Radio | 29 Jane Novak, Blues Singer of Twin Cities, WCCO |
| 5 Coon-Sanders' "Nighthawks" at KYW | 30 Jean Sargent, the original, now at WHT |
| 6 George Hay, 1924 Gold Cup announcer | 31 Ralph Emerson, popular organist at WLS |
| 7 Harmony Girls, Edith Carpenter, Grace Ingram | 32 Edna Adams, "Sweetheart of the Air" at KPRC |
| 8 Ford and Glenn, Lullaby Boys of WLS | 33 Pat Barnes, vaudeville announcer at WHT |
| 9 "Roxy" Rothafel of WEAJ chain fame | 34 R. V. Haller of KGW Hoot Owls fame |
| 10 The Hired Hand, famous "Substitute Announcer" of WBAP | 35 Henry L. Dixon, ukulele wizard of KYW |
| 11 Britt and Finch, popular songsters | 36 Quin Ryan, WGN's Uncle Walt and sports announcer |
| 12 Bob Emery, Big Brother of WEEI | 37 "Willie the Weeper," Ernest Rogers, WSB |
| 13 "Bill" W. G. Hay, ex-KFKX, now of WLIB | 38 Walter Wilson, "Uncle Bob" of KYW |
| 14 Happiness Boys, jovial singers of WEAJ | 39 Jack Chapman of Drake hotel repute |
| 15 Lambdin Kay, "Little Colonel" of WSB | 40 Ray-O-Vag Twins, known country-wide |
| 16 Leo Fitzpatrick, "Merry Old Chief," WJR | 41 Art Linick, KYW's Mrs. Schlagenhauer |
| 17 Henry Field, 1925 Gold Cup runner-up | 42 Fred Hamm of WTAS, now WLIB, fame |
| 18 Al Carney, organ favorite at WHT | 43 Meyer Davis' Le Paradis orchestra of WRC |
| 19 Aunt Jane, ladies' adviser at WOC | 44 "Senator Schultz, WLW's illiterate comic |
| 20 Vincent Lopez, No. 1 Pennsylvania orchestra | 45 "Uncle John" Daggett of KHJ |
| 21 E. L. Tyson, pleasing voice at WWJ | 46 D. R. P. Coats, 1925 Silver Cup announcer |
| 22 S. W. Barnett, ex-WOC, now WBAL | 47 Gene Rouse, WOA's popular announcer |
| 23 Art Gillham, "The Whispering Pianist" | 48 Freda Sanker, WKRC jazz orchestra director |
| 24 Paul Greene, announcer at WSAI, "bridge voice" | 49 Iris Ruth Pavey, KOA's invisible stage beauty |
| 25 Harry Ehrhart, "Dream Daddy" of WLIT | 50 Queen Titania, star of KHJ Fairyland |
| | 51 Ipana Troubadours, on the WEAJ Chain. |

If your favorites are not in this list, send in a request to have them included in the Gallery of Radio Stars.

COUPON NO. 9

This coupon entitles the holder to one photogravure selected from the Radio Digest Gallery of Radio Stars when accompanied by ten cents to pay the cost of mailing and postage.

Three consecutively numbered coupons entitle the holder to three photogravures when accompanied by 25 cents. Remittance must accompany the coupon. Cash at your risk. Add 5 cents to personal checks for exchange.

Order by Number.....
Radio Digest Publishing Co., 510 N. Dearborn St., Chicago



Fred W. Stein.

Steinite

Low Loss
Interference Eliminator
No Radio Set Complete Without It

Select stations at will. With music and voices crowding the air the average set fails to bring in the desired stations properly. The Steinite Interference Eliminator shuts out local and other interference. You get one station at a time, the one you want, and tune in loud and clear. Operates on any set—attach to aerial wire and to set—no changes—no extra tubes or batteries. Greatest Dollar Value in Radio Today. Over 150,000 Sold

Improved Results with Tube or Crystal

Try entirely at my risk the wonderful improvement this inexpensive little device will make in the reception of your set. Improves results on both crystal and tube sets that use any kind of aerial except loop antenna. Clears up reception wonderfully, increases volume, and partially absorbs static. Money-Back Guarantee.

Mrs. Famous 1,500 MI. Steinite 1-Tube Set, \$6; Long Distance Crystal Set, \$6; Steinite Crystal 50¢—Three for \$1.

Steinite 5-Tube Set \$29.75

FREE Descriptive Literature on request.

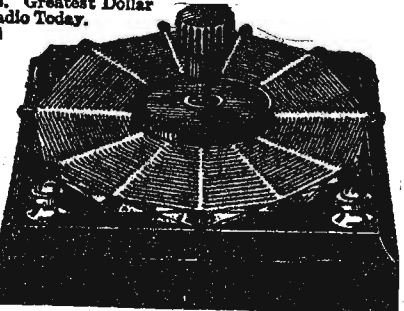

\$1 Postpaid If you are not delighted with results you get your dollar back

Put this interference eliminator on your set and note amazing improvement. No tools needed—install in a moments time. Connect with set and follow simple instructions. Money back promptly if not delighted. \$1.00 postpaid anywhere in U. S. when cash with order.

References: Exchange National Bank, Atchison Savings Bank. Order today—a dollar bill will do.

STEINITE LABORATORIES, 161 Radio Bldg., ATCHISON, KANSAS

Two-Tube Short Wave 15-130 Meter Receiver

Part II—Drilling and Assembly

By John G. Ryan

WHILE THE following point to be discussed will not present you with any problem, the writer is quite sure that most of the readers of this series will be interested in some of the factors that led to the placing of the parts as they have been finally arranged. When the set designer goes below the 200-meter point on the wave length range he runs into what might be called absorption. Parts must be so placed that there is the minimum possible metal of any nature in the fields of the coils and near the variable condensers. This practice is also true in designing broadcast receivers but in this latter work it is to prevent broadening of the tuning while in connection with short wave sets it is to avoid dead spots. If an error is made it will be noticed in tuning that there will be several places in the possible range where regeneration and oscillation cannot be secured.

For example, you might be using the intermediate coil and the grid variable condenser approaches 40 on the dial. The

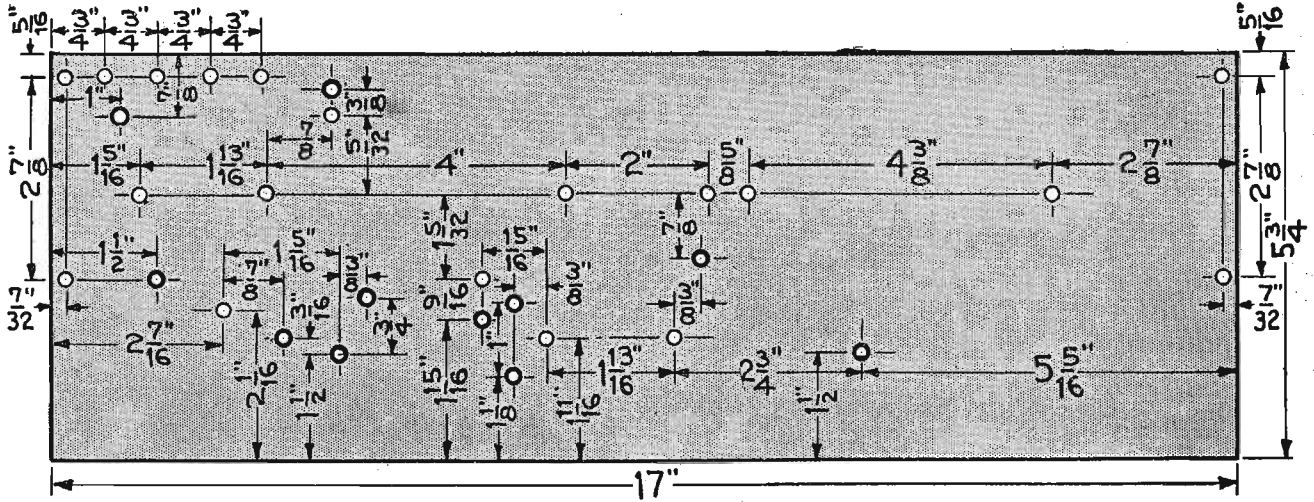

Figure 4

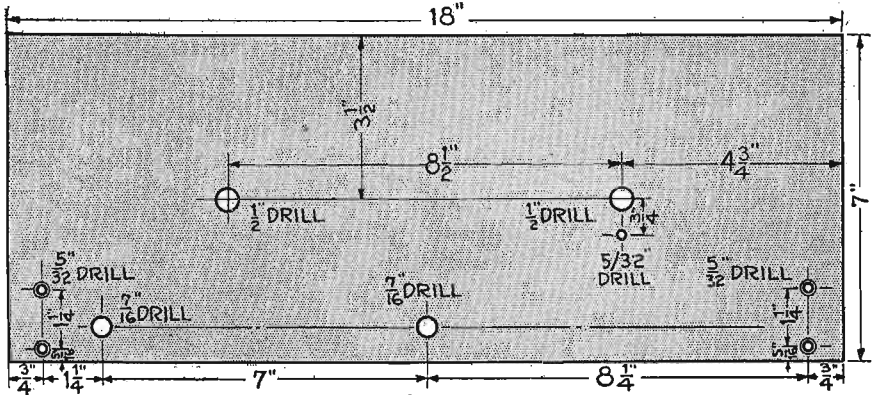

Figure 3

plate variable condenser is being kept in synchronism for maximum regeneration. Suddenly you find that no amount of adjusting will give sensitivity. As you continue up the scale, you find that at

Considering now figure 6, which is the photograph of the top view, you will note that we have been very careful to keep the inductances well back from the variable condenser and the audio transformer,

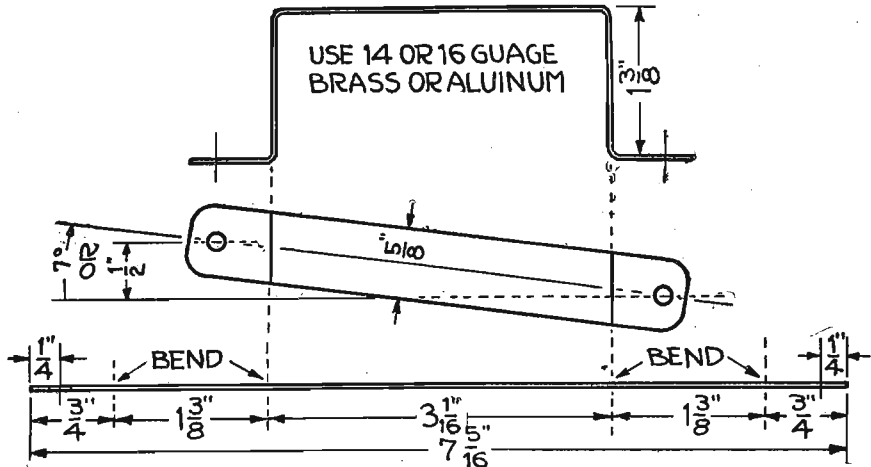

Figure 5

55 and on up to 100, perfect control is possible. Those wave lengths falling between 40 and 55 could not be received over any great distance. There may be as many as three or four such dead bands if care is not used.

with its large masses of iron, well to the left. It might possibly be another inch back from the left variable condenser but as this is the feedback condenser and not the grid circuit capacity, no difficulty has been noticed. No metal other than that

in the unit itself is near the right-hand condenser (.00014 mfd. maximum) and none is near the coils. The primary has all the needed room to permit swinging it clear out at right angles. Such loosening of the coupling is necessary in many cases to clear up dead spots due to peculiarities of the antenna installation. With close coupling, the antenna and ground circuit may absorb negative resistance as fed back from the plate circuit preventing regeneration and long range at certain points on the condenser scale.

With these points in mind, we come to the actual assembly of the various parts. Figure 3, presented with this article, shows the drilling of the front panel, while figure 4 shows the drilling of the sub base. In connection with figure 4 it should be called to your attention that holes outlined with a light circle are apparatus mounting holes to be drilled 9/64" or 5/32" while those holes outlined with a heavy circle are to pass the wir-

ing and may be drilled much smaller or to just pass bus bar. At this point I note an omission in connection with the list of parts which should have included a Carter number 103 jack with a list price of 90 cents. This is my error, though I checked that list several times.

The two large holes midway the height of the panel and 8 1/2 inches apart are for the Karas condensers using the single hole mounting feature. As these condensers are now shipped they include a small special wrench for tightening the nut on this mounting which makes this very easy. The condensers are turned so that the short side of the end plates is horizontal with the longer side slanting up to the left. Bradleystat goes in the lower hole in the center and is mounted horizontally, the terminals being up. While drilling the holes in this front panel put a 5/32" hole just 1/4" below the left condenser shaft hole. Each Mar-co (Continued on page 28)

Big Price Reduction

FULTONE LOUD SPEAKER FOR YOUR PHONOGRAPH

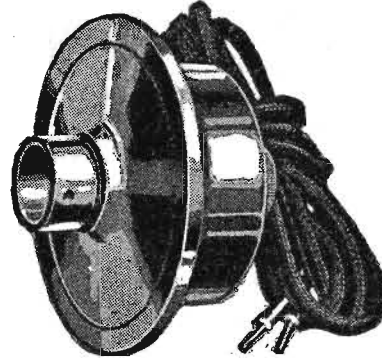

Fits Any Make

Now Only

\$3⁰⁰

Fultone
TRADE MARK

LOUD SPEAKER UNIT

\$3⁰⁰

The unit will be shipped on a satisfaction or money back basis on receipt of price in money order or currency.

This unit is the secret behind the unparalleled success of Fultone Speaker. Its large diaphragm and bobbins of fine wire are protected from injury by a heavy nickel-plated case through the back of which adjustment is made by means of a special key. The pole pieces are not made from a solid piece of iron but are assembled from 15 laminations of carefully chosen steel.

Tear Off, Fill in, Mail Now

HALL & WELLS, Inc., 4600 Lincoln Avenue, CHICAGO, ILL.
Enclosed is \$..... for which ship me.....
() Fultone Unit at once, my money to be refunded if I am not satisfied and return this merchandise within 5 days.
NAME
ADDRESS
CITY AND STATE

Use on Your Phonograph

- Edison Adapter.....25c
- Columbia or Pathe.....20c
- Brunswick.....30c

HALL & WELLS, Inc.
4600 Lincoln Ave. Chicago, Ill.

The World is Yours with The New UNCLE SAM Master Tuning COIL

Many owners of sets equipped with Uncle Sam Coils hear London, Aberdeen, Scotland, Madrid, and other European stations. Why confine yourself to local stations when by using Uncle Sam Coils the world is yours.

FREE Four-page coil circular in colors. Write for it.
Uncle Sam Electric Co., East 6th St. Plainfield, N.J.

THE COIL WITHOUT LOSSES THE CONNECTING LINK

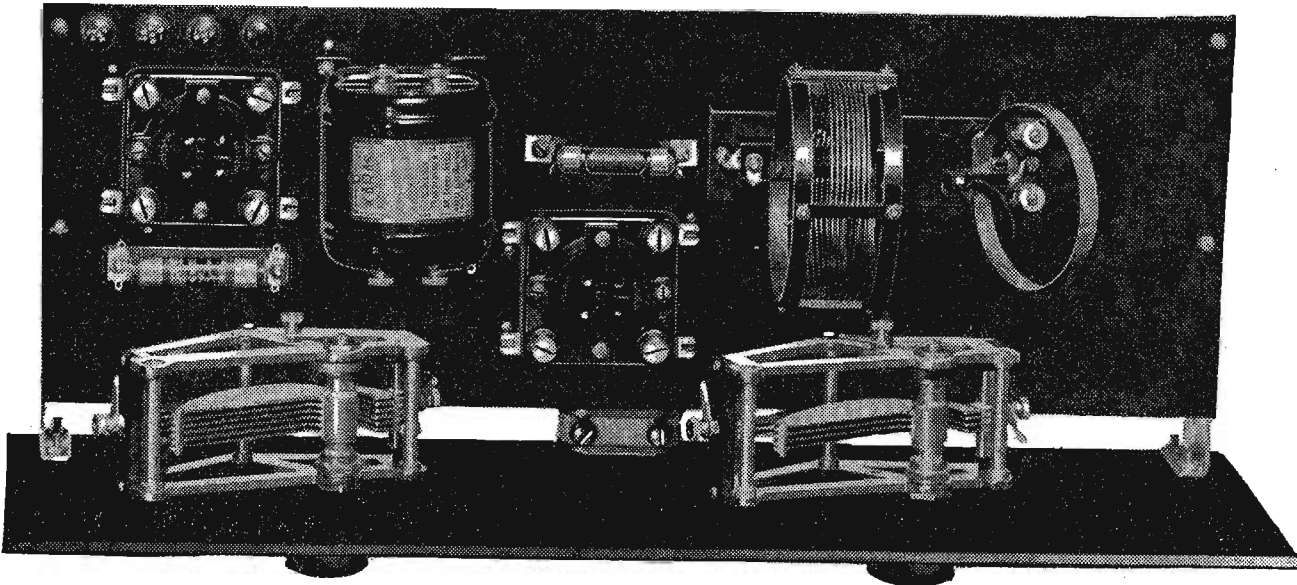

Figure 6

SHORT WAVE RECEIVER

(Continued from page 27)

dial requires an anchor hole. Use care in countersinking the holes for the bracket screws for, if they are overdone, there will be an undesirable little ring showing around the screw head.

Sub Base Layout

Going now to figure 4 on the sub base, the two holes at the left edge are for the Benjamin brackets. At the rear edge, the next four holes are for the Eby binding posts. Going forward a little there is a line of holes clear across sub base. The two at the left, 1 13/16 inch apart are for the Eby socket used as the audio amplifier. We are speaking now only of apparatus mounting holes. The two 4 inches over and 2 inches apart are for the clips of the Daven Leakandenser. The last two to right and 4 3/4 inches apart take the Aero coil mounting. At the extreme right edge are two, placed fore and aft for the second bracket.

Down in front and centered are two

holes 1 11/16 inches from front and 1 13/16 inches apart for the Eby socket taking the tube used as detector. With these holes all located, no trouble should be had in spotting the three remaining, two of which are for the Karas transformer and one for the Amperite mounting. In connection with the transformer,

if P and G are placed to the right, the rear left and front right mounting holes are utilized. When securing the sockets in place, put the P and G terminals to the right in both cases.

Part of the detector grid circuit can be completed when assembling the coil mounting and the Leakandenser. It will

be noted that the G terminal of the coil mount is right next to the left end mounting screw. The writer loosened the G plug-in receptacle so that the soldering lug beneath it could be turned to go under the screw holding the left end of the mount to the sub base. On the underside of sub base, a long soldering lug is fastened under the nut holding right end of Leakandenser and turned so its free end goes under the nut on the left end mounting screw of coil mounting. Thus the circuit is completed from the G terminal of coil mount, through the mounting screw, across to right end of Leakandenser, through it to left end. Later it will only be necessary to connect left end of this unit to the G terminal of detector socket.

The use of the brass strip shown as figure 5 may not be clear at this stage of the assembly. After the wiring is put in with exception of C battery, an Eveready C battery of the 4 1/2-volt type is secured to the underside of two of the mounting screws which hold apparatus. The strip shown will, if bent correctly, hold the C battery in correct position and underneath the sub base out of the way.

Why Input Is at Right

This short wave set has been designed with the input to the right and output to the left for two reasons. The broadcast listener will use it in conjunction with his 200 to 550-meter set in which the input is at the left and output at the right. The short wave set can be placed to the left and the antenna and ground leads can be brought to a switch-over arrangement placed between the two sets. (Continued on page 29)

BASE NOTES FULLY AMPLIFIED!

There is no variation in amplification over the entire range of musical frequencies with Thordarson Autoformers. No note is too low—no note is too high to be fully amplified by the Autoformer.

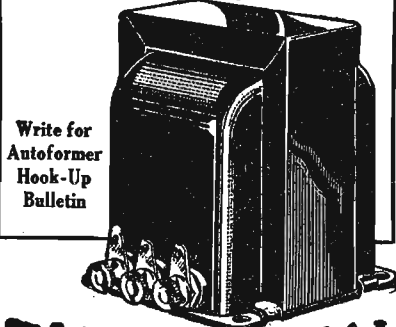

Write for Autoformer Hook-Up Bulletin

THORDARSON Autoformer

Trade-Mark Registered

All Frequency Amplifier
An Entirely New Instrument—
Not "just another transformer"

As the world's oldest and largest exclusive makers of transformers, we have led for years in broadening their amplifying range. In the Autoformer we have finally developed an all-frequency amplifier—a new instrument capable of fully amplifying all notes audible to the human ear. Thus the deepest notes of the grand organ, bass viol, tuba, English horn, etc., at last are brought out as clearly as the highest treble. Improved long distance reception and better volume control are further advantages.

Write for Autoformer Bulletin

Autoformer amplification is for those who seek the finest reproduction of programs to be had. May be used with any set in place of regular audio transformer hook-up. Full directions, with diagrams, supplied with each instrument. Autoformers are \$5 each.

Sold by leading dealers
THORDARSON ELECTRIC MFG. CO. CHICAGO

The New Radio Book HOW TO

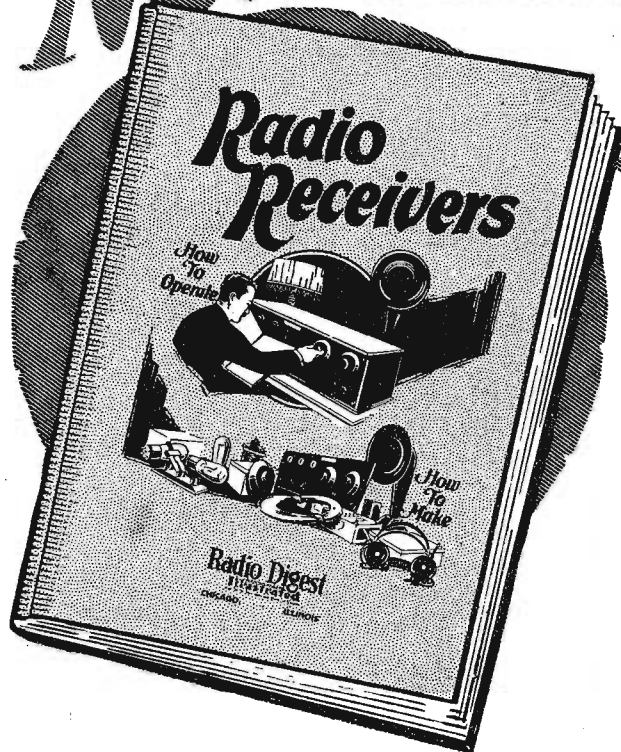

Operate Sets
Construct Parts
Improve Reception
Understand Radio
Assemble Circuits

FREE With One Year's Subscription to Radio Digest

THE greatest assemblage of facts and hints, from actual everyday practice, ever gotten together. Edited by the technical staff of Radio Digest it supplies the demand for a book covering every phase of Radio from a simple explanation of Radio reception to a technical explanation of the different parts of a set which leads to the best reception possible. The sections on selecting and making sets develops the different types of sets and circuits with diagrams to explain same. "How to Operate" gives detailed information on the operation of all the well-known sets. The section of general information contains a complete Radio map and schedule and a section of workshop kinks which save time and money. Now is the time to take advantage of the exceptional offer as listed in the coupon for your convenience.

Read what one of our readers has to say.

"This is also to say that I received your treatise on radio (Radio Receivers) and I consider it one of the most remarkable and most valuable books on radio that I have ever seen. You are to be congratulated on this work."

RADIO DIGEST,
510 N. Dearborn St.,
Chicago, Ill.

2-20-26

Enclosed find five dollars for one year's subscription to Radio Digest including FREE the New 124 Page Radio Book called "Radio Receivers—How to Operate and How to Make."

NAME.....

ADDRESS.....

CITY..... STATE.....

This Handy Radio Reference Book Is Yours Today

Use the Coupon—Mail Today

The Reader's View

You Are Right

I have been interested to read of the federal suit against WJAZ for pirating wave lengths. Believe me, they are not the only ones by any means. WSMB does this regularly to get away from KOA, and I can't say I blame them. KSL, Salt Lake City, (299) has been working about one degree above WLIB (302) for some time. Evidently they couldn't get in between KPRC (296) and WLIB. Quite evidently it is impossible for powerful stations to operate independently on a three meter split or less.

Why do you not come out and admit this editorially. Theoretically, it may sound all right, but actually, I guess no one is better aware of the fallacy than yourself.—R. K. Valley Ranch, N. M.

Disagrees with L. F. W.

I note in your issue of January 2, where L. F. W. of Conway Springs, Kans., is thoroughly "fed up" on the average broadcast program. I want to make a few comments.

If the type of music he wants was broadcast exclusively, about 75 per cent of the receivers would be abandoned. Furthermore, if he has a receiver that is at all worth while, he can get enough jazz and junk to suit him, without being compelled to listen to programs that are not intended for him at all. There are plenty of stations that feature old-time and popular music.

His last paragraph explains his complete knowledge of music. Eliminating songs with titles in foreign languages would bar most of the worth-while music. He probably has just found out that the majority of favorite operas are in some language not his.—C. R. W., Crenshaw, Miss.

No Innocent Broadcaster

Do you know the color of persuasion that might be used to get some innocent broadcaster to send us a number of something not played by a band or an orchestra?—E. E., Mount Sterling, Ky.

Well, C. E. J., What Kind Is It?

In your column headed "The Reader's View" I noticed that C. E. J. of Boston, Mass., picks up 10-watt stations over a distance of 1,300 miles. I would like to know the type of receiver C. E. J. uses, as I have a very sensitive set that does not give such reception. I would like to improve my reception by a tip from C. E. J.—J. M. H., Lake Charles, La.

Moon Should Be Considered

With the international tests completed, may I offer a suggestion in the hope for better results next year? I was successful in hearing only 6KW, Cuba; PWX, Cuba, and CZE, Mexico, the latter being the only station I had not logged before. All these stations came in with clear and distinct volume.

I lay my failure to get more stations to the fact that it was full moon, and herein lies the hint of my suggestion. Why not consider the phase of the moon when fixing the time for the tests? The first two weeks of January were better

TOMSK, SIBERIA, FAN WANTS YOUR LETTER

FROM Tomsk, Siberia, to the offices of Radio Digest is quite a span of miles, but Radio has made this distance shorter for at least one Russian there. Alexander Kalachnikoff reads Radio Digest and listens to American stations, both amateur and broadcasting. But he wants to get better acquainted with Americans. Then, too, he has a sister, Vera, eighteen years of age, who would like to write to American sisters.

Coming as it did from this far-off country, Siberia, where the resources have but been scratched, where a great civilized nation of thousands of millions of people may sometime exist, "A's" letter quite naturally aroused much interest.

You may read it too. The letter has been but slightly corrected. Note how well he writes English.

"English Speaking Radio Amateurs"

"I am a Russian amateur, who wants to have a friendly correspondence with you. I will be glad if you will send me American literature, books as well as magazines, for which I with pleasure will send you, if you want, Russian postage stamps and paper money issued during the Russian revolution, and also Russian magazines, views etc.

"As to me it is very difficult to pay postage, I beg you to enclose in letters some International postage reply coupons. "Don't delay to write me! I am waiting! My name and address:

Al. Kalachnikoff,
Tomsk, Siberia, Russia,
Soldatska Street, 66.

"P. S. I have a sister Vera, eighteen years old, who will be glad to correspond with American girls. If you have a sister, let her write a letter to my sister."

He's Just a Lonely Radio Fan

So ends the letter from "Al." He's just a Russian Radio fan, thousands of miles away, and living in a lonely country. He gives no hint of his age, except of course, we may hazard a guess that he is a few years older than his sister, Vera.

The editor says he is going to write to Al, and hopes other people will also correspond. One thing not to forget, however, in mailing a letter to Russia is that the postage required is five cents. International reply coupons may be secured at the post office.

by far than the last two weeks for distance reception—G. E. M., Pittsburgh, Pa.

Should Answer Letters

As the fans always notice, an announcer will ask listeners to send cards or letters thanking the artists. Now don't you think that after you take your good time to write and thank them for the program or to verify some program, that the least they could do would be to acknowledge (Continued on page 30)

Fans, Here's Something to Puzzle Over—Your Guess Is as Good as Ours

Radio Digest:

Solve this if you can. The man that operates a grain elevator in Meckling, S. Dak., a town nine miles west of here, has a Radio which he uses to get the stock returns and market reports. Another man, Lee Steele, who owns a ranch three miles this side of Meckling, has a large gasoline engine which he uses to shell corn for his cattle.

When Lee Steele, the rancher, has his engine running, the elevator owner can tune in on his Radio and hear the engine and Lee Steele's voice, or any other person's voice who happens to be close to the engine. I did not hear it but other people have when listening in at the elevator. I suggest that Steele be given some call letters.—Maurice Kirby, Vermillion, S. Dak.

AID FARMERS BY RADIO

(Continued from page 4)

If this "National Agricultural College of the Air," assuming the term is permissible, rides upon the crest of popularity (literal and figurative) in keeping with its high purpose and mission of service, it may eventually become a daily instead of a weekly feature. Then a farmer in the vicinity of Waupaca could send a telegram to Washington, telling about symptoms of cholera among his hogs or tuberculosis among his herd of dairy cows and receive helpful information by Radio the following day. This and thousands of other similar illustrations suggest the necessity and the opportunity of Radio in affording timely information to the tillers of the soil.

As an outgrowth of the germ "Fifty Farm Flashes," there will be many offshoots to this big idea of linking the laboratories of the great United States Department of Agriculture to the firesides of farm homes. The fertile brain of the Chief of Radio Service is ebullient with ideas that will both speed up and popularize the unlimited agricultural information on tap in Washington. Already, Mr. Pickard has created the character of "Uncle Bert, the Garden Expert," who like Uncle Josh and similar personages that savor of the soil, is destined to national fame. Uncle Bert would serve as the foster father of thousands of boys and girls who would enlist under the banner

"Radio Order of Junior Gardeners." And this, too, is a far-reaching implication because either unintentionally or through neglect the juniors or boys and girls in their teens are not now recognized in the programs of broadcasting stations.

The kiddies, of course, are served their bedtime stories, but the boy who is just putting on his first galluses is not the beneficiary of a special Radio program. Mr. Pickard, with a keen insight into human nature and the quickness to recognize an opportunity, is to supply that deficit or missing link in the field of broadcasting.

The fertile ideas of Mr. Pickard, although his plans are now of a tentative nature, are not those of a theorist. From a wealth of practical experience, as director of KSAC, broadcasting station of the Kansas State Agricultural college, he was drafted by Secretary of Agriculture William A. Jardine, where (in Washington) his intensive and sound ideas will have room for expansion beyond a state boundary to that of a national scope. In other words, a state "College of the Air," with 5,000 farmers as regular students, becomes a "National Agricultural College of the Air," with unnumbered millions of farmers as potential students. Such is the important role to be played by Sam Pickard, and with keen enthusiasm, ripe experience and special training, he will fully measure up to the large duties thus imposed.

SHORT WAVE RECEIVER

(Continued from page 28)

The battery leads can also be brought to this switching arrangement if desired. In the case of the transmitting amateur, he usually has his transmitter, either phone or CW, to the right with the switch-over and key in the center and receiver at the left. Thus this set will fit into his arrangements with short antenna and ground leads.

(The wiring of short wave receiver will be taken up in the third installment to be presented next week.—Editor's Note.)

The vacuum-type lightning arrestor is generally considered the best. Before installing the arrestor the underwriters' rules for the locality in question should be consulted.

FREE!

12-Cell—24-Volt Storage 'B' Battery

Positively given free with each purchase of a WORLD 'A' Storage Battery. You must send this ad with your order. WORLD Batteries are famous for their guaranteed quality and service. Backed by years of successful manufacture and thousands of satisfied users. Equipped with Solid Rubber Case, an insurance against acid and leakage. You save 50 per cent and get a **2-Year Guarantee**

Bond in Writing WORLD Battery owners "tell their friends." That's our best proof of performance. Send your order in today.

Solid Rubber Case Radio Batteries

- 6-Volt, 100-Ampere . . . \$11.25
- 6-Volt, 120-Ampere . . . 13.25
- 6-Volt, 140-Ampere . . . 14.00

Solid Rubber Case Auto Batteries

- 6-Volt, 11-Plate . . . \$11.25
- 6-Volt, 13-Plate . . . 12.25
- 12-Volt, 7-Plate . . . 16.00

Send No Money Just state battery wanted and we will ship day order is received, by Express C. O. D., subject to your examination on arrival. **FREE "B"** Battery included. **Extra Offer:** 5 per cent discount for cash in full with order. Buy now and get a guaranteed battery at 50 per cent saving to you.

WORLD BATTERY COMPANY CHICAGO, ILL.

World STORAGE BATTERIES

Set your Radio Dials at 240 meters for the new 1000 watt World Storage Battery Station, WSBC, Chicago. Watch for announcements.

WKA-WFAP-WGN-WJS-KHJ-KGO-KFAP-WJY-KO

New Revisable 62 page LOG and Radio Book of Knowledge

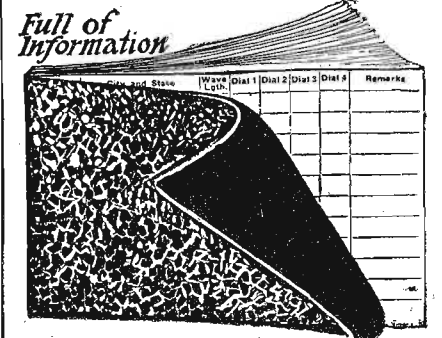

Send No Money

62 pages valuable information necessary to enjoy your radio. 10 Radio volumes bound as one. Beautiful cover. Gold lettering. Loose leaves for inserting revised pages. We print new pages as changes occur in wave lengths, owners, addresses, calls, watts, etc., and as new facts and discoveries are secured. We ship latest edition. A few features of this "up-to-the-minute" Radio Book are log holding 468 stations, Dictionary Radio Terms, Tuning Suggestions, Trouble Finders, Trouble Preventers, Care of Batteries, An Ideal Aerial, Repair Helps, Station List numerical by wave lengths—both in meters and kilocycles, List alphabetical by states and cities, List of Owners and Addresses, Answers to Questions, Calibration Chart showing dial settings for each wave length, etc. So convenient. Get clearer programs. Increase your selectivity. Eliminate your troubles. Enjoy your radio MORE. Worth many times small cost. Write NOW for radio pleasure book.

Large Colored RADIO MAP FREE With First Order

Pay postman \$1 after latest \$2.00 edition revisable Radio Book and FREE map arrive. Postpaid if pay with order. Money refunded if not delighted. Order today—NOW. Radio Printers, Dept. 8912M, Marengo, Ill.

22½ Volt un-acid everlasting rechargeable "B" STORAGE BATTERY \$2.95

Includes Chemical

45 volts, \$5.25; 90 volts, \$10.00; 112½ volts, \$12.50; 135 volts, \$14.75; 157½ volts, \$16.80. Truly the biggest buy today. Easily charged on any current including 52-volt systems. Any special detector plate voltage had. Tested and approved by leading authorities such as Popular Radio laboratories. Over 3 years sold on a non-refundable 30-day trial offer with complete refund if not thoroughly satisfied. Further guaranteed 2 years. Knock-down kits at great savings. Complete "Hawley" "B" battery charger, \$2.75. Sample cell, 35c. Order direct—send no money—simply pay the expressman cost on delivery. Or write for my free literature, testimonials and guarantee. Same Day shipments. B. Hawley Smith, 817 Washington Ave., Danbury, Conn.

100% BETTER TONE

MOUNTFORD Resistance Coupled Amplifier Kit R.C.3 Price \$6.50

With this kit, you can quickly and easily change from transformer to Resistance-Coupled Amplification and get better tone, real clarity, and greater volume.

Sent postpaid, with \$6.50 hook-up diagram, price \$6.50

SATISFACTION GUARANTEED OR MONEY REFUNDED

C. E. MOUNTFORD 463 Greenwich St. NEW YORK CITY

The Crescendon, Crosley's new and exclusive volume control, enables you to build up scarcely audible signals from distant stations to dancing volume—and to cut down local super-power stations to a whisper without impairing tonal qualities. Hear it on models 4-29 and 5-38!

Add 10 per cent to all prices west of the Rockies

THE CROSLLEY RADIO CORPORATION, Cincinnati, Ohio

CROSLLEY RADIO

BETTER • COSTS LESS

The Reader's View

(Continued from page 29)

your message, even if it be only a card? And now, the widely discussed "Who shall pay for broadcasting?" I think that it ought to be put up to each city council and at election time have the city vote upon it that the city or county assess all owner of Radios and compel them to pay even one-half mill (.05c) on each hundred dollars tied up in Radio in their home.

Regarding popular and classical music, I, myself, would rather hear a good orchestra play a few jazz numbers than to hear an "old hen" soprano sing "Love's Dawning."—C. A., Columbus, Ohio.

HELP STOP BLOOPING

(Continued from page 26)

bring up the regeneration on DX, and frequently spill over, you can do so without upsetting the whole community. You have the three dials on the set logged for about everything within range anyway, so they can all be found readily on the new dial. Remember, if you do it, and you "sell" two or three other men at the office on the idea, and each of them gets his neighbors to do it, pretty soon your community will be "one sweet place" for Radio reception.

In figure 4 we have a typical input circuit for a super-heterodyne. This is not the worst offender, but it causes plenty of trouble. In this case we use an untapped loop with one side going to the grid of the mixer tube (first detector) and the other to its filament. The pick-up coil from the oscillator is connected in that lead going to the filament and therein lies the trouble. The loop will radiate merrily, causing trouble throughout a whole city block. If, instead of a loop, you use an antenna coupler, with tight coupling between antenna circuit and secondary, said secondary being connected to J1 and J2, the grief you cause over a wide area is terrific. One remedy is to cut down the voltage applied to the oscillator so that the oscillations are of low amplitude or strength; very little is required to mix properly and most supers would "perk" a lot better for their owners if only 22 to 30 volts were on that oscillator plate.

Super-Het Suggestions

Another suggestion is the use of one of the radiation preventing stages of balanced tuned R.F. but it will have to be slightly altered from the usual arrangement for use on a super-het. As sold, Penetrola and the rest of them have an output arrangement to be coupled onto a tuner but the super has only a variable condenser and the tuner part must be incorporated into the output of the added stage. The supers mentioned in the first few paragraphs of last week's article each had one, and such a stage will be described later. It will help a great deal to shield your super well—all over—and while you're doing it shield the oscillator from the rest of the set for your own good. The oscillator coils can radiate very well themselves, in all directions, which not only bothers others but gets into parts of your set where you do not want it. The overall shielding will prevent radiation from your intermediate stages when you bring them up to oscillation. True they are long wave oscillations but what a lot of lower wave harmonics they have—anywhere from two to ten and from 100 meters up.

The worst super from the standpoint of radiation is the type with the center tapped loop and the midget condenser going to the plate of the mixer tube. How they can go! The loop circuit is brought

up to maximum sensitivity and then the operator (?) starts to bring up the intermediates with the potentiometer. Closer and closer, more and more distortion, then over it goes—taking the mixer or first detector with it. Mixer oscillating, oscillator oscillating, intermediates going full blast, possibly also the second detector. Feature the ethereal racket if that combination is on an aerial instead of a loop. Lots of them are. The secondary of the antenna coupler is center tapped, just as though it were a loop, with a primary of from 6 to 12 turns. If by chance the antenna circuit is tuned with a honeycomb load coil and variable condenser the very maximum in blooping is achieved.

If you must couple to an antenna, first of all take off the center-tap feature, for the sake of humanity; second, move the antenna coil at least an inch from the secondary, and third, take off some turns of the primary coil. This last move will make the step-down ratio greater for oscillations going out and cut down their radiating ability. You'll still have one mighty good super, it will be a lot sharper and, frankly, you'll get a lot purer reproduction. Incidentally, while doing this, completely shield the antenna coupler and its secondary tuning condenser and see how much less local interference you have—also less harmonics from anything within a hundred miles.

(Next week we'll get into the operation of present-day sets for better results with less blooping. Charting dials, and the relationship between regeneration controls and tuning dials, will be among the points considered. Stick with this series as later we'll get into other forms of interference that may bother you—Editor's Note.)

Get Better Programs



YOUR OWN Name and Address Printed Free on Applause Cards. Entertainers expect and appreciate applause cards, YOUR appreciation makes them perform better. Applaud your favorites. FREE LOG with 1st Order

Space for requests. Stations gladly put on request numbers. Quality cards and printing. 50—only \$1; 100—\$1.45; 200—\$1.95; 500—\$2.45. Money refunded if not delighted. Send No Money and FREE Log. Order today—NOW. Radio Printers, Dept. 7992, Marengo, Ill.

Collect Radio Stamps Album FREE

For limited time, we will give ABSOLUTELY FREE a large 48 PAGE Radio Album & Log, with each order for 168 beautiful copper-etched radio stamps (8 colors) each a different station. As you hear stations, insert proper stamps. Album contains other information. 100 hours pleasure. Fascinating hobby. Permanent record. You, your children and friends will enjoy it.

Send No Money Pay postman \$1 after stamps & FREE album arrive. Postpaid if pay with order. MONEY REFUNDED if not DELIGHTED. Order NOW. IDEAL CO., Dept. 4412, 366 Wrigley Bldg., Chicago

Save Money on Your Ratheon-B-Eliminator



Complete Parts with RAYTHEON Tube and full instructions NOW ONLY \$28.95

Your opportunity to purchase at a great saving, complete set of parts and directions for building your own "B" Eliminator! Genuine Raytheon Tube, Thordarson Chokes and Transformers. Only nationally advertised parts. Operates any number tubes, no hum. Money back guarantee. Save one half cost by building. Plug in any 110 V. A.C. socket and your "B" Battery troubles are over. FREE Send immediately for Free Instructions and Particulars MACK LABORATORIES 719 Cass Street Chicago, Ill.

ARE YOU THE MAN

to be first in your town to sell and demonstrate POWEROLA, the famous 5 tube NO-BATTERY ELECTRIC LIGHT SOCKET RADIO RECEIVER (not an attachment), universal for D.C. or A.C. (100-115 v. 40-60 cycle), now sold and demonstrated thru THE NEW YORK EDISON CO., public utility companies and radio, electric and music dealers everywhere. Absolutely dependable, fully guaranteed, powerful, practical, perfect in performance. Are You The Man Who Sees Opportunities Ahead for Real Money Making? Write for literature, terms and prices at once.

You, Too, Can Make Powerola Send \$1.00 for wiring diagrams showing parts used and how to make any set or circuit (one to eight tubes) operate satisfactorily from A.C. or D.C. current. POWEROLA RADIO CORP. Dept. E.D., 1945 Broadway New York

ADVANCE PROGRAMS

(Continued from page 21)

WSAI, Cincinnati, Ohio (325.9m-920kc), 7 p. m., program; 7:30, Hires Harvesters; 8, Clicquot Club Eskimos; 9, Silvertown Cord orchestra, Joseph Knecht, director.

WGB, Atlanta, Ga. (428.3m-700kc), 8 p. m., Monroe Georgia high school orchestra; 10:45, entertainment.

Mountain Time Stations KOA, Denver, Colo. (322.4m-930kc), 12:15 p. m., Biallo theater organ, Marjorie Nash; 6:30, Brown Palace string orchestra; 8, Scheuerman's Colorado orchestra; 8:15, Edith Louise Jones, piano studios; Paul Clarke Stauffer, director; Frank Fowler, Waldo Williamson, cellists; Hans Esser, violinist; Ned Steel, violinist; Stanhope E. Blunt, tenor; Bella Marmor, pianist; Gladys Henshall, Louise Metz, Lawrence Crittenden, pianists; Mark O'Brien, pianist; KOA orchestra.

Pacific Time Stations CNRV, Vancouver, Can. (291.1m-1030kc), 7:30 p. m., bedtime story, Aunt Ruby; 8:30, Mrs. Lyle Telford, soprano; J. W. Hargrave, tenor; Maud Kler, cellist, operatic solos; 10:30, Cabaret Belmont orchestra, Bebe Mullar, soprano.

KFI, Los Angeles, Calif. (467m-642kc), 5:30-6 p. m., Kenneth Morse and his orchestra; 6, nightly doings; 6:15, KFI's Sealing California; 6:30, vest pocket program; 6:45, Radianical period; 7-8, Varied program; 8-9, Aeolian residence pipe organ, Dan L. McFarland, organist; 9-9:30, program arranged by Wm. MacDougall, Scotch comedian; 9:30-10, Mutual Motors mirth contest; 10-11, popular song hour.

KFWB, Hollywood, Calif. (252m-1190kc), 7:30 p. m., Officer E. G. Brown in safety first talk; 7:20, Jack Boaz, hunting and fishing scout; 7:30, "Eye-o-logue," Dr. S. Marshutz; 7:45, microphone brevities; 8-9, Ray Bailey's trio; Lois Woody, soprano; Frank Stever, baritone; Estelle Shale, blues singer; 9-10, Mrs. Vivian Kidson, soprano; Tom Brennan, baritone; Warner Brothers syncopators; 10-11, Warner Brothers frolic, direction Charlie Wellman.

KGO, Oakland, Calif. (361.2m-830kc), 7:15-7:30 a. m., health exercises; 7:45, Pep class; 8:15-8:30, exercises; 11:30-1 p. m., Sherman Clay and company luncheon concert; 3-4, Florence Archibald, soprano; Will Mur-

Big Money in Radio

Demand for high pay radio men is so great that a big Kansas City wholesale concern is now fitting men free to get into the radio business for themselves and make \$60 to \$200 a week without any capital invested. Select territory open. Send today for free catalog and amazing offer. Write direct to Mr. H. J. Saizow, Standard Radio Co., 1440 Walnut St., Kansas City, Mo.

DON'T TRY TO TUNE BY GUESS

KNOW where to place your dials for each station in America. KNOW what station you receive without waiting announcement. You can do both with RADEX. Send 25c Coin or Stamps. RADEX, Box 143-L, CLEVELAND

RADIO INVENTIONS

Protected by U. S. and Foreign Patents MASON, FENWICK & LAWRENCE Patent and Trade Mark Lawyers Washington, D. C., New York, Chicago Established Over Sixty Years

References: LIFE SAVERS INC., PORT CHESTER, N. Y. STEPHEN F. WHITMAN & SON, PHILADELPHIA PACIFIC COAST BISCUIT CO., SEATTLE, WASH. LOFT, INC., NEW YORK CITY SPRAGUE WARNER & CO., CHICAGO THE WARREN CO., ATLANTA, GA. A. BALDWIN & CO., NEW ORLEANS, LA. JOSEPH BURNETT CO., BOSTON

Send Description and Sketch RADIO We want to hear from hard-hitting radio dealers operating live-wire stores who want to make the best jobber connection in America. DEALERS Our eight big warehouses furnish you with the finest products in radio. And we ship fast. WANTED Write today on your letterhead for big catalog or nationally advertised lines. Ask for AE 1 06 WAKEM & McLAUGHLIN, Inc. 225 E. ILLINOIS STREET, CHICAGO, ILL.

ray, tenor; Marie Cain, pianist; 4-5:30, Hotel St. Francis concert orchestra, Vinton Laforteva, conductor; 5:30-6, girls half hour, Esther Wood Schneider, conductor; 6-6:55, Brokaw and his orchestra.

GET THIS BIG RADIO CATALOG FREE Simply send name TODAY for big 64-page book explaining liberal proposition paying agents \$60 to \$100 a week, and how to make money from latest radio goods. Live dealers and agents wanted. Standard Radio Co., 1442 Walnut St., Kansas City, Mo.



The wonderful SUPERFLEX radio NEW CIRCUIT—ONE DIAL (one condenser—pat. pendg.) Not reflex. Volume, Clarity, Distance, Selectivity. Sample to RATED DEALERS. TEST ONE. RADIO PRODUCTS CORPORATION, (Inc.) 3816 N. 28th St. Birmingham, Alabama

New—Different The Beautiful, De Luxe Radio Log You've Always Wanted. The Wonder Radio Log Rich seal grain binding, stamped in gold; top edge gilt, 144 pages, size 5x7 1/2. Printed on heavy bond paper. A Log you will be proud of. Lists the Broadcasting Stations three convenient ways—(1) by Call Letters; (2) by Locations and Owners; (3) by Kilocycles and Meters. Includes 24 page Wonder Radio Diary by months and days, and Wonder Radio Distance Map. Ample space for keeping complete Log and for changes, additions and revisions. Sent post paid \$1.00. Order your copy now. You'll be delighted with it or money refunded. WONDER RADIO LOG CO., 711 South Dearborn, CHICAGO, ILL.

Long Distance Radio Only \$2.95 LAMBERT RADIO 200,000 SATISFIED OWNERS Getting stations 600 miles away on Lambert Radios. No batteries or tubes required. A real Radio—not a toy or attachment. One to four can listen at once. No howling or screeching noises. Hear local stations on bedsprings, light sockets or telephone. Fully guaranteed. Set, \$2.95—Phones, \$2.95—Aerial, \$1.00. Mail orders filled same day. We pay postage. LEON LAMBERT RADIO CO. 212 So. Market St., Wichita, Kansas

SAVE ONE HALF Buy Direct From Factory, LANES Guaranteed \$12.50 or C.O.D. Products Now, by our method of direct dealing, we actually save you the dealer's discount and give you two powerful, high class, handsome looking products each at \$12.50 and equal to any at 3 times the cost. 100 Volts Storage B BATTERY NON-ACID 78 Cells—Wonderful Reception Best for 5 Tube Sets Works from either A. C. or D. C. Each regularly sold for \$35. Now \$12.50 Greatest values. Finest reception. Lowest upkeep cost. Handsome steel crystalline case with rubber feet. We guarantee no disappointments. Mail your order today. Lane Mfg. Co. 2941 West Lake Street Dept. 26, Chicago

CLASSIFIED ADVERTISEMENTS

SALESMEN WANTED Make \$100 WEEKLY in spare time. Sell what the public wants—long distance radio receiving sets. Two sales weekly pays \$100 profit. No big investment, no canvassing. Sharpe of Colorado made \$955 in one month. Representatives wanted at once. This plan is sweeping the country—write today before your county is gone. OZARKA, INC., 126-G, Austin Ave., Chicago.

RADIO "\$1.00 For Your Old Tubes regardless of make or condition towards the purchase of each new Standard \$2.50 tube. Positively guaranteed. We do not sell rebuilt or bootleg tubes. Order today. Luxem & Davis Mfg. Co., 6229 Broadway, Chicago, Ill. Paste this ad in your set."

TELEGRAPHY Telegraphy—Both Morse and Wireless taught thoroughly. Big salaries. Wonderful opportunities. Expenses low; chance to earn part. School established fifty years. Catalog free. Dodge's Institute, Sixth St., Valparaiso, Ind.

ELIMINATE STATIC! Enjoy perfect reception regardless of weather conditions. The Static Eliminator—the newest and most startling thing in Radio—cuts out practically all static without loss of volume! And in addition it will help increase selectivity, tune out local stations, sharpen signals, remove noises, lessen interference and prevent re-radiation! Use it with any receiving set—simply hook up according to our simple instructions and enjoy perfect reception unmarred by static. Satisfaction absolutely guaranteed—Money back if Eliminator is returned within 5 days. Mail your order today. \$1.00 Postpaid



WAKEM & McLAUGHLIN CO. 621 United Bank Bldg. Chicago, Ill.

Radiophone Broadcasting Stations

Corrected Every Week—Part III

FIND MISTAKES AND YOU'LL GET DOLLAR

ONE DOLLAR will be paid to the Radio fan reader of Radio Digest submitting the most errors in any one station's listing in the Directory of Radiophone Stations, which appears in six parts, serially continuously on the next to last page. Letters must reach Radio Digest's office not later than one week from date of issue corrected. Readers are not limited to correcting one station, but such corrections must be verified by the stations themselves, and NOT by comparison to other so-called accurate Radio directories or lists. Verifications must accompany corrections. Turn in corrections for as many stations as you can find—if you can find errors! Use separate sheet of paper for each station submitted and place name and address on each sheet. In case of tie, duplicate awards will be made.

United States (Cont'd)

*NOTE.—*The third part of the schedule list appears below. The fourth part which consists of the remainder of the list will appear next week.

- WEAL**, Ithaca, N. Y. 254.1m-1180kc. 500 watts. Cornell University, irregular.
- WEAM**, North Plainfield, N. J. 260.7m-1150kc. 250 watts. Borough of North Plainfield. Announcer, H. W. Blackford. Slogan, "America's Pioneer Municipal Broadcasting Station." Fri, 8-12 pm, concert, talks, Eastern.
- WEAN**, Providence, R. I. 270.1m-1110kc. 500 watts. The Shepard Stores. Announcer, Chester H. Miller. Daily ex Sun, 12-1 pm, 4-5, music, reports, weather, concert; 6:30-10:30. Sun, 10:45-11:30 am, 7:30-8:45 pm, church service. Eastern.
- WEAO**, Columbus, Ohio. 293.9m-1020kc. 500 watts. Ohio State University. Daily ex Sun, 9:45 am, 11-1 pm, markets, weather; talks to farmers, markets, music; 4, markets. Tues, 9 pm. Wed, 4:10 pm, program for shut-ins; 8, music, lectures. Thurs, 8 pm, lectures, music. Eastern.
- WEAR**, Cleveland, Ohio. 359.4m-770kc. 750 watts. The Goodyear Tire & Rubber Co. Announcer, H. K. Carpenter. Slogan, "Goodyear Tires WEAR." Daily ex Sun, 11-12:10 pm. Daily ex Sat, Sun, 3:30-4:10 pm, markets, weather. Daily, 7-8 pm. Tues, Thurs, Fri, 8-11 pm. Sun, 3:30-5 pm, 7-10. Eastern.
- WEAU**, Sioux City, Iowa. 275.1m-1090kc. 100 watts. Davidson Bros. Co. Announcer, W. O. Ducommun. Slogan, "The Heart of the Corn Belt." Daily ex Sun, 9 am, 10, 11, 12 m, 1 pm, 6, markets, weather, sports. Central.
- WEEB**, Superior, Wis. 241.8m-1240kc. 100 watts. Telegram-Ross Elec. Co. Daily ex Sun, 6:15-8 pm. Mon, 8:30-9:50. Wed, Sat, 9-11 pm. Central.
- WEED**, Anderson, Ind. 245.8m-1220kc. 15 watts. Elec. Equipment & Service Co. Announcer, F. R. Fulwider. Tues, Fri, 8:30 pm. Sun, 7:30 pm, service. Central.
- WEER**, Cambridge, Ohio. 234.2m-1280kc. 10 watts. Roy W. Walter. Off the air indefinitely.
- WEBB**, Chicago, Ill. 370.2m-810kc. 1,500 watts. Edgewater Beach Hotel-Herald-Examiner. Announcer, Robert Boniel. Slogan, "The Voice of the Great Lakes." Daily ex Sun, 11:30-12 m, 3-4 pm. Daily ex Sun, Mon, 7-8 pm, 11-12. Daily ex Sun, Mon, Fri, 11-12:30 pm. Fri, 1-12 pm. Sun, 5-6 pm, twilight music. 7-9. Central.
- WEBJ**, New York, N. Y. 272.6m-1100kc. 500 watts. Third Avenue Railway Co. Announcer, H. A. Bruno. Tues, Fri, 7-9 pm. Wed, 8-10 pm. Eastern.
- WEBL**, 225.4m-1330kc. 10 watts. Radio Corporation of America. (Portable).
- WEBM**, Mobile, Ala. 225.4m-1330kc. 100 watts. Radio Corporation of America. (Portable).
- WBEQ**, Harrisburg, Ill. 235.4m-1330kc. 10 watts. Tate Radio Co. Announcer, Joseph R. Tate. Slogan, "Blue Bird Station." Daily ex Sun, 7:15-7:30 pm, news, weather. Sun, 3-4 pm. 7-8. Central.
- WEBS**, Buffalo, N. Y. 243.8m-1230kc. 100 watts. H. H. Howell. Slogan, "We Extend Buffalo's Regards." Daily ex Sun, 7:45-8:30 pm, bedtime stories. Mon, Wed, Fri, 8:30-11:30 pm. Sun, 12 m, 3 pm. Eastern.
- WEBW**, Beloit, Wis. 268 meters. 500 watts. Beloit College. Announcer, Lee Boynton. Mon, 8-9 pm. Sun, 4:30 pm. Central.
- WEBZ**, Savannah, Ga. 263m-1140kc. 50 watts. Savannah Radio Corp. Mon, Wed, Fri, 8:30 pm. Eastern.
- WEEL**, Boston, Mass. 348.6 meters. 500 watts. Edison Elec. Illuminating Co. Announcer, C. R. Emery. Slogan, "The Friendly Voice." Daily ex Sun, 6:45 am, exercises; 7:45, watch. Mon, 4 pm, 6:30, 6:30-10:30, 10:30. Tues, 3 pm, 4, 6:30-10, 10. Wed, 4 pm, 6:30-10, 10. Thurs, 4 pm, 6:30-10, 10. Fri, 4 pm, 6:30-10, 10. Sun, 7:20 pm, 9:20. Eastern.
- WEHS**, Evanston, Ill. 202.6m-1480kc. 20 watts. Robert E. Hughes.
- WEMC**, Berrien Springs, Mich. 285.5m-1050kc. 1500 watts. Emanuel Missionary College. Slogan, "The Radio Light House."
- WENR**, Chicago, Ill. 265.3m-1130kc. 1,000 watts. All-American Radio Corp. Announcer, Frank Westphal. Daily ex Sun, Mon, 6-7 pm, 8-10. Wed, Fri, Sat, 12-2 am. Sun, 2-4 pm, 9:30-11:30. Central.
- WEW**, St. Louis, Mo. 247.8m-1210kc. 100 watts. St. Louis University. Daily ex Sun, 9 am, 10, 2, 5 pm, reports. Tues, Thurs, 7 pm, lectures, music. Sun, 7-15 pm. Central.
- WFAD**, Dallas, Tex. 475.9m-630kc. 500 watts. Dallas News and Dallas Journal. Slogan, "Working for All Alike." Daily, 6:30-7:30 am, exercises; 8:30, 9:30, 10:30, 11:30, reports; 12:30, 1:30, 2:30, 3:30, 4:30, reports, news; 5:30, children's hour; 8:30-9:30, concert, weather (silent Wed.). Mon, Tues, Thurs, Fri, Sat, 6:30-7:30 pm, vespers, recital, sports. Tues, Thurs, Sat, 11-12 pm, music. Sun, 6-7 pm, Bible class; 7:30, church service; 8:30-9:30, 11-12, music. Central.
- WFAA**, St. Cloud, Minn. 272.6m-1100kc. 10 watts. St. Cloud Daily Times. Slogan, "Granite City of the World." Announcer, Otto A. Rupp. Daily ex Sun, 4:45 pm, markets. Central.
- WFAV**, Lincoln, Neb. 275.1m-1090kc. 500 watts. Univ. of Nebraska. Central.
- WFBC**, Knoxville, Tenn. 249.9m-1200kc. 50 watts. First Baptist church. Announcer, St. John Reynolds. Sun, 10:45 am; 7:30 pm, services; 4 pm, sacred music. Central.
- WFDL**, Philadelphia, Pa. 234.2m-1280kc. 5 watts. Gethsemane Baptist church.
- WFBE**, Seymour, Ind. 225.4m-1330kc. 10 watts. Van de Walle Music and Radio Company. Announcer, John Van de Walle.
- WFBG**, Altoona, Pa. 277.6m-1080kc. 100 watts. The Wm. F. Gable Co. Announcer, Roy F. Thompson. Slogan, "The Original Gateway to the West." Daily ex Sat, Sun, 11:45 am, music; 3:30 pm; 6:30, 8:30. Tues, Fri, 11:45 pm. Sun, 10:30 am; 4 pm, 6, 7:30, 9:15, 11:15. Eastern.

- WFBH**, New York, N. Y. 272.6m-1100kc. 500 watts. Concourse Radio Corp. Announcer, Alvin E. Hauser. Slogan, "Voice of Central Park." Daily, 11:30 pm. Mon, Tues, Fri, 2-7 pm. Wed, Thurs, Sat, 12-8 pm. Sun, Sat, 11:30 pm. Sun, 5-8 pm. Eastern.
- WFBK**, Camden, N. J. 236.1m-1270kc. 500 watts. Galvin Radio Supply Co.
- WFBM**, Collegeville, Minn. 236.1m-1270kc. 50 watts. St. John's university. Announcer, Hilary Doerffer. Slogan, "In the Heart of the Landscape Paradise." Sun, 5-4:45 pm. Central.
- WFBL**, Syracuse, N. Y. 252m-1190kc. 100 watts. Onondaga Hotel company. Announcer, Ernest E. Chappell. Daily 3-4 pm, 6-8, Tuesday, 9:30-10:30 pm. Thurs, 7:45-10 pm. Fri, 8:15-10 pm. Sat, 11-12:30 am. Sun, 3-4:30 pm, 5-8:30. Eastern.
- WFBP**, Indianapolis, Ind. 267.7m-1120kc. 250 watts. Merchants Heat and Light company. Announcer, John E. Tribby. Slogan, "The Convention City of America."
- WFBT**, Baltimore, Md. 254.1m-1180kc. 100 watts. Fifth Infantry, Maryland National Guard. Slogan, "Home of the Star Spangled Banner." Announcer, S. R. Kennard. Day matinee programs. Tues, Thurs, Sat, evening programs. Sun, afternoon program. Eastern.
- WFBZ**, Galesburg, Ill. 254.1m-1180kc. 20 watts. Knox college.
- WFDF**, Flint, Mich. 234.2m-1280kc. 100 watts. Frank D. Fallain. Slogan, "The Vehicle City." Mon, Wed, Fri, 8 pm. Eastern.
- WFEL**, Philadelphia, Pa. 394.5m-760kc. 500 watts. Strawbridge & Clothier. Announcer, John Vandensloot. Daily ex Sun, 10:15 am, reports; 10:30, music; 10:40, home service; 1-1:50 pm, orchestra; 1:50, reports; 3-4:30, concert; 6:30-7, orchestra. Tues, Thurs, Sat, 8, concert. Sun, 10:30 am, 7:30 pm, church services alternating; 9:15, alternate Sundays. Eastern.
- WFKB**, Chicago, Ill. 217.3m-1380kc. 500 watts. Francis K. Bridgman. Announcer, Horace Kehm. Daily ex Sun, Mon, 7-10 pm. Central.
- WFL**, Brooklyn, N. Y. 205.4m-1460kc. 100 watts. Fleischhacker Laboratories.
- WGAL**, Lancaster, Pa. 247.8m-1210kc. 10 watts. Lancaster Elec. Supply & Construction Co. Announcer, J. R. Galtner. Slogan, "World's Gardens at Lancaster." Mon, Wed, Fri, 5:45-6:15 pm, dinner concert. Wed, 11:15-1 am, organ. Eastern.
- WGBB**, Freeport, N. Y. 243.8m-1230kc. 100 watts. Harry E. Carman. Mon, Wed, Fri, 8-10:30 pm. Sun, 10:40 am, church. Eastern.
- WGBD**, Memphis, Tenn. 277.6m-1080kc. 10 watts. First Baptist church. Announcer, M. L. Martin. Sun, 9:55 am, 7:30 pm. Central.
- WGBF**, Evansville, Ind. 236.1m-1270kc. 500 watts. The Finke Furniture Co. Announcer, Harold Finke. Daily ex Sun, 12:10 pm, weather. Tues, Fri, 8-10 pm. Central.
- WGBI**, Scranton, Pa. 240 meters. 100 watts. Frank S. Mesergue.
- WGBM**, Providence, R. I. 234.2m-1280kc. 100 watts. Theodore N. Saaty. 234.2m-1280kc. 100 watts. Theodor N. Saaty.
- WGBR**, Marshfield, Wis. 228.9m-1310kc. 10 watts. George S. Ives. Sun, 2-4 pm. Central.
- WGBS**, New York, N. Y. 315.6m-950kc. 500 watts. Gimbel Brothers. Announcer, Floyd Neale. Daily ex Sun, 10-2:30 pm, entertainment; 3-7:30. Tues, 8:30-12. Thurs, 8:30-1 am. Sat, 7:30-12. Sun, 3:30-4:30 pm, 9:30. Eastern.
- WGBU**, Fultford, Va.-By-the-Sea, Fla. 277.6m-1080kc. 500 watts. Fultford By-the-Sea Chamber of Commerce. Announcer, Edward C. J. Sandback. Mon, Wed, Fri, 12-1 pm, 6:30-7:30, 11-2 am. Tues, Thurs, Sat, 12-1 pm; 6:30-7:30; 10-1 am. Sun, 9:30-11:30 pm. Eastern.
- WGBX**, Orono, Me. 252 meters. 500 watts. University of Maine.
- WGCP**, New York, N. Y. 252m-1190kc. 500 watts. Grand Central Palace. Announcer, Alfred Hall. Slogan, "Four Leaf Clover Station." Daily ex Sun, 3:30-8:30 pm. Mon, 8:30-10:30 pm. Wed, Fri, 7:30-8:30 pm. Thurs, 10:30-12 mid. Sat, 8:30-11 pm. Sun, 3-5:30 pm. Eastern.
- WGES**, Oak Park, Ill. 249.9m-1200kc. 500 watts. Coyne Elec. School. Announcer, John Stamford. Daily ex Sun, Mon, 5-7 pm; 8-9 pm; 11-1 am. Mon, 5-7 pm. Sun, 5-7:40 pm, 11-12. Central.
- WGHG**, Clearwater, Fla. 263.3m-1130kc. 500 watts. The George H. Bowles Developments. Daily ex Sun, 6:30-7:30 pm; 8:30-9:30; 11:45-1 am. Eastern.
- WGHM**, Detroit, Mich. 270.1m-1110kc. 1,500 watts. George Harrison Phelps, Inc. Announcer, Harry C. Browne. Daily ex Sat, Sun, 6 pm. Eastern.
- WGMU**, Richmond Hill, N. Y. 236.1m-1270kc. 100 watts. A. H. Grebe & Co., Inc. (Portable).
- WGN**, Chicago, Ill. 302.8m-990kc. 1000 watts. Chicago Tribune. Announcer, Bill Hay. Daily ex Sun, 9:45 am, news; 10-10:45; 11-11:30; 11:57-12:01 pm, time; 12:01-12:30, music; 3:25; 3:30-4:15, tea time music; 4:30-5, organ; 5:30-5:57, Skeezix; 5:57-6:30, time; 6:20-6:30, bonds; 6:30-7, music. Tues, Thurs, Fri, 11:30-11:57 am, household hints. Tues, Thurs, 12:30-12:40 am, farm talk. Tues, Wed, 3-3:25 pm, talks. Daily ex Sun, Mon, 8-11 pm. Sun, 10:45-11:45 am, Uncle Walt; 11:45-1:15 pm, music; 2-5:15, music; 7-10, Sunday evening concert. Central.
- WGR**, Buffalo, N. Y. 319m-940kc. 750 watts. Federal Radio Corp. Announcer, Kenneth Flckett. Slogan, "Key City of Industry." Daily ex Sun, 12 m, reports; 12:45, concert; 2:30; 6:30 pm, music; 7:30, news. Mon, Wed, Fri, 9-1 am, Tues, Thurs, 8-11 pm, from New York. Sun, 3 pm, vespers; 7:45, church; 9:15, concert. Eastern.
- WGTA**, Atlanta, Ga. 270.1m-1110kc. 500 watts. Georgia School of Technology. Announcer, J. H. Persons. Slogan, "The Southern Technical School with a National Reputation." Mon, 9 pm, Thurs, 7 pm. Central.
- WGY**, Schenectady, N. Y. 379.5m-790kc. 500 watts. General Electric Company. Announcer, Kolin Hager. Daily ex Sun, 11:55 am, time; 12:30 pm, stocks, markets; 12:45, weather. Daily ex Sun, 12:40 pm, fruit, vegetable reports; 6, stocks; 6:10, markets; 6:15, sports, news. Mon, Tues, Thurs, Fri, 2 pm, woman's hour. Tues, Thurs, 2:30 pm, organ. Mon, Tues, Thurs, 6:30-7 pm, dinner program. Thurs, 11:30 pm, organ. Fri, 7 pm; Wed, 6:30, stories. Fri, 6:30 pm, Sunday school lesson; 10:50, late program. Mon, 7:15 pm, agriculture talk. Wed, Fri, 7 pm, orchestra. Sat, 9:30 pm, dance program. Sun, 10:30-12 am, service; 5 pm, organ; 7, Carillon program; 7:30-8:45 pm, service; 8:45 pm, orchestra from WJZ. Eastern.
- WHA**, Madison, Wis. 335.4m-560kc. 750 watts. Univ. of Wis.
- WHAD**, Milwaukee, Wis. 275.1m-1090kc. 500 watts. Marquette University. Milwaukee Journal. Announcer, Ed. Rank. Daily, 11 am, weather, news; 4-5 pm, news, markets, current topics, music; 6-7, organ, orchestra; financial reports. Mon, 8-10 pm. Tues, 9-9:30 pm, Wed, 10:30-12:30, Fri, 8:30-10 pm. Central.
- WHAM**, Rochester, N. Y. 277.6m-1080kc. 100 watts. Univ. of Rochester. Rochester Time-Union, Democrat and Chronicle. Daily ex Sun, 3:30-4 pm, 5-5:45, 7-7:40. Wed, 8-10 pm. Sat, 10-12 mid. Sun, 8:15, Radio Chapel. Eastern.
- WHAP**, New York, N. Y. 239.9m-1250kc. 500 watts. William T. Taylor Finance Corp. Announcer, Franklin Bond. Slogan, "The Station for Public Service." Daily ex Sun, 6-11 pm. Sun, 2-3:30 pm. Eastern.
- WHAR**, Atlantic City, N. J. 275.1m-1090kc. 500 watts. Seaside Hotel. Announcer, E. Dennison. Daily ex Sun, 2 pm, 7:30, 8. Tues, Fri, Sun, 11:15 pm, organ. Mon, Thurs, 11:30 pm. Sun, 10:45 am; 2:15 pm, 2:45, 7:50, 9. Eastern.
- WHAS**, Louisville, Ky. 399.8m-750kc. 500 watts. Courier-Journal and Louisville Times Co. Announcer, D. E. Ives. Daily ex Sun, 1-2 pm, 2:30-3:30, 5:45, 7:30-9. Sun, 9:57-10:45 am, 4:30-5:30 pm, church service. Mon night, silent. Central.
- WHAT**, Minneapolis, Minn. 263m-1140kc. 500 watts. Twin City Business Men's Broadcasting station. Announcer, Dr. George Young. Mon, 6-8 pm, 9-11.

- Tues, 7-8 pm. Wed, 6-10 pm. Fri, 7-11 pm. Central.
- WHAV**, Wilmington, Del. 265.3m-1180kc. 100 watts. Wilmington Elec. Spec. Co. Slogan, "The First Broadcasting Station of the First City of the First State." Temporarily discontinued.
- WHAZ**, Troy, N. Y. 379.5m-790kc. 1000 watts. Rensselaer Polytechnic Inst. Announcer, Rutherford Hayner. Slogan, "Transcendental and International Broadcasting Station Located at the Oldest College of Science and Engineering in America." Club, R. P. I. students. Mon, 9-12 midnight, concert, educational talks, orchestra, features. Second Monday of month, 12-1:30 am. International test program. Eastern.
- WHB**, Kansas City, Mo. 365.6m-820kc. 500 watts. Sweeney Auto & Electric School. Announcer, John T. Schilling. Slogan, "Heart of America." Daily ex-Sun, 8:25 am, 9:25, 9:30, 9:35, 10:25, 10:30, 10:35, 11:20, 11:30, 11:35, 11:55, 12 noon, market reports. Daily ex-Sun, Sat, 12:15 pm, 12:30, 1:25, 1:40, stocks; 2, music; 3-3:05, U. S. W. B.; 3:05, markets; Tues, Thurs, 7-7:45 pm, dinner hour music; 8-10, evening concert. Mon, Wed, Fri, 7-8 pm. Sat, 12:05 pm, 12:30, 1:25, markets. Sun, 9:45-10:45 am, service; 11-12:15 pm; 8-9:15, service; 11:15-1 am, organ. Central.
- WHBA**, Oil City, Pa. 249.9m-1200kc. 10 watts. Shaffer Music House.
- WHBC**, Canton, Ohio. 254.1m-1180kc. 10 watts. Rev. E. P. Graham. Mon, 8-8:30 pm. Eastern.
- WHBD**, Bellefontaine, Ohio. 222.1m-1350kc. 20 watts. Charles W. Howard (Portable).
- WHBF**, Rock Island, Ill. 222.1m-1350kc. 100 watts. Beardsley Specialty company. Announcer, C. L. Beardsley. Mon, Wed, 7-9 pm. Sat, 2-4 pm, 7-9. Central.
- WHBG**, Harrisburg, Pa. 230.6m-1300kc. 20 watts. John S. Skane. Tues, Thurs, 9-12 midnight. Fri, 7:45-9:15 pm. Sun, 1:45-11 pm. Eastern.
- WHBH**, Culver, Ind. 222.1m-1350kc. 100 watts. Culver Military Academy. Announcer, Charles C. Mathier. Mon, 8:30 pm, Sat, 7:15 pm. Central.
- WHBJ**, Ft. Wayne, Ind. 234.2m-1280kc. 50 watts. Lauer Auto company.
- WHBK**, Ellsworth, Maine. 230.6m-1300. 10 watts. Franklin St. Garage, Inc.
- WHBL**, Logansport, Ind. 215.7m-1390kc. 50 watts. James H. Slusser. (Portable).
- WHBM**, Chicago, Ill. 215.7m-1390kc. 20 watts. C. L. Carroll. (Portable).
- WHBN**, St. Petersburg, Fla. 238m-1260kc. 10 watts. First Avenue Methodist church.
- WHBP**, Johnstown, Pa. 256.3m-1170kc. 10 watts. Johnstown Automobile Co. Announcer, J. C. Tully. Slogan, "The Voice of the Friendly City." Wed, 8 pm. Sat, 10 pm. Eastern.
- WHBO**, Memphis, Tenn. 232.4m-1290kc. 50 watts. Men's Fellowship class. St. John's M. E. church. Announcer, George L. Powers. Slogan, "We Have Best Quartet." Wed, 8-9 pm, music. Sun, 9:45-10:45 am, 11, 7:45 pm, services. Central.
- WHBU**, Anderson, Ind. 218.8m-1370kc. 10 watts. Bing's Clothing-Riviera Theater. Announcer, O. B. Robey. Slogan, "The Home of Chief Anderson." Daily ex Sun, 9-9:30 am, 12-12:30 pm. Wed, Fri, Sun, 7-9 pm. Central.
- WHBW**, Philadelphia, Pa. 215.7m-1390kc. 100 watts. H. K. Kezzie. Mon, evening.
- WHDI**, Minneapolis, Minn. 277.6m-1080kc. 500 watts. Wm. Hood Dunwoody Industrial Institute. Announcer, M. R. Bass. Mon, 8-9 pm. Wed, Fri, 9-10 pm. Central.
- WHCC**, Rochester, N. Y. 258.5m-1160kc. 100 watts. Hickson Electric company, Inc. Announcer, Maurice Clark. Slogan, "With Hickson Elec. Co." Daily ex Sun, 5:30-6 pm, twilight program; 6:30-7 orchestra. Eastern.
- WHCL**, Cleveland, Ohio. 272.6m-1100kc. 250 watts. Radio Air Service Corp. Winton Hotel. Slogan, "Cleveland, The Convention City." Daily ex Sun, 6:30-7:30 pm. Thurs, 7:30-9 pm, music. Sun, 10:30 am, service; 6:15-7:15, 7:45-8:30, Bible lecture; 8:30-10, music. Eastern.
- WHN**, New York, N. Y. 360m-833kc. 500 watts. Loew's State Broadcasting Station. Announcer, N. T. Grandlund. Slogan, "The Voice of the Great White Way." Daily ex Sun, 12-1 pm, 2:15-3:15, 3:45-5:30, 8-12 midnight. Sun, 3-6 pm, 9:30-12. Eastern.
- WHO**, Des Moines, Ia. 526m-570kc. 5000 watts. Bankers Life Co. Announcer, N. Dean Cole. Daily ex Sun, 9:45 am, 12 m, 2 pm, markets, weather. Mon, Tues, Thurs, Fri, 7:30-9 pm. Weds 6:30-7:30 pm, 7:30-9, 9-10, 10-11:30. Fri, 11-12 mid. Mon, Tues, Thurs, 11-12 midnight. Sun, 11 am, 1 pm, 7:30-8:30. Central.
- WHT**, Chicago, Ill. 238m-1260kc. 399.8m-750kc. 2500 watts. Wrightley Bldg. Announcer, Patrick Henry Barnes. Daily ex Sun, Mon, (399.8), 10-2 pm, 6-7:30, 9:30-1 (238), 7:45-9:15 pm. Mon, (399.8), 11-2 pm, 7-1 am. Sun, 12-11:30 pm, Paul Rader. Central.
- WIAD**, Philadelphia, Pa. 249.9m-1200kc. 100 watts. Howard R. Miller. Slogan, "The Voice from the Birthplace of Liberty." Tues, Fri, 9 pm. Eastern.
- WIAS**, Burlington, Ia. 254.1m-1180kc. 100 watts. Home Elec. Co. Announcer, Harry H. Waugh. Slogan, "Burlington, on the Mississippi." Tues, 8-9 pm, concert. Thurs, 7-8 pm, concert. Sat, 10:30-11, organ. Sun, 10:30 am, church services. Central.
- WIBA**, Madison, Wis. 236.1m-1270kc. 100 watts. The Capital Times. Announcer, Trevor Griffiths. Slogan, "Four Lakes City." Mon, Wed, 8:45-10 pm. Fri, 8:45-10:30 pm. Sat, 12:01-2 am. Central.
- WIBG**, Elkins Park, Pa. 222.1m-1350kc. 50 watts. St. Paul's Protestant Episcopal church. Announcer, Stuart C. Mahoney. One Monday a month. Agonizantz Abbey, Elkins Park, 10:45 am, 3:45 pm. Eastern.
- WIBH**, New Bedford, Mass. 209.7m-1450kc. 30 watts. Elite Radio Stores. Announcer, J. T. Moriarty. Slogan, "The Voice of New Bedford." Daily ex Sun, 12-1:30 pm. Sun, 1-3 pm. Eastern.
- WIBI**, Flushing, N. Y. 218.8m-1370kc. 50 watts. Frederick B. Zittell, Jr.
- WIBJ**, Chicago, Ill. 215.7m-1390kc. 50 watts. C. L. Carroll. (Portable).
- WIBK**, Chicago, Ill. 215.7m-1390kc. 10 watts. Billy Malie. (Portable).
- WIBO**, Chicago, Ill. 225.4m-1330kc. 1,000 watts. Nelson Brothers. Announcer, Wayne Meyers. Daily ex Sun, 2-4 pm. Daily ex Sun, Mon, 6-8 pm. Tues, Thurs, 12-3 am. Wed, 10-12 midnight. Fri, 10-2 am. Sun, 10:15 am, service; 2-4 pm, concert; 6-8, 10-12. Central.
- WIBR**, Welton, W. V. 245.8m-1220kc. 50 watts. Tri-State Radio Co. Announcer, W. D. Johnston. Slogan, "The Town Where Everybody Works." Fri, 8:30-11 pm. Sat, 11-1 am. Sun, 2-3 pm. Eastern.
- WIBS**, Elizabeth, N. J. 202.6m-1480kc. 10 watts. New Jersey National Guard.
- WIBU**, Poynton, Wis. 222.1m-1350kc. 20 watts. The Electric Farm.
- WIBV**, Henderson, N. C. 263m-1140kc. 500 watts. Jewell Radio Co.
- WIBW**, Logansport, Ind. 220.4m-1360kc. 100 watts. Dr. L. L. Dill.
- WIBX**, Utica, N. Y. 205.4m-1460kc. 150 watts. Grid-Leak, Inc.
- WIL**, St. Louis, Mo. 272.6m-1100kc. 250 watts. St. Louis Star and Benson Radio Co. Announcer, Billy Knight. Slogan, "Watch It Lead." Tues, 4-5 pm; Thurs, 4-5 pm, 8-12. Sat, 4-5 pm; 10-12. Central.
- WID**—?
- WIP**, Philadelphia, Pa. 508.2m-590kc. 500 watts. Gimbel Bros. Announcer, E. A. Davies. Slogan, "Watch Its Progress." Daily ex Sun, 7-7:30 am, 1-2 pm, 3-4:30, 6-6:45, music; 7-7:30 pm. Tues, Thurs, Sat, 8-12 pm, concert. Sun, 10:45-12 noon, 4:15-5:30 pm, 7:45-9, 10-12. Eastern.
- WIAD**, Waco, Texas. 352.7m-850kc. 500 watts. Barton's Dyanshine Station. Mon, Tues, Thurs, Fri, 8:30-1 pm. 1st and 2nd Wed, 8:30-9:30 pm. Central.
- WIAG**, Norfolk, Neb. 270.1m-1110kc. 200 watts. Norfolk

- Daily News. Announcer, Karl Stefan. Slogan, "The World's Greatest Country Daily, and Home of Printer's Devil." Daily ex Sun, 12:15 pm; Sun, 3:30-6 pm, music. Central.
- WJAK**, Kokomo, Ind. 254.1m-1180kc. 50 watts. Clifford L. White. Slogan, "The Radio Person." Daily ex Sun, 12 noon, news. Sat, 6 pm, Sunday school lesson. Central.
- WJAM**, Cedar Rapids, Iowa. 267.7m-1120kc. 100 watts. D. M. Perham. Tues, Thurs, Sat, 7-10 pm. Sun, 4 pm, vesper service. Central.
- WJAR**, Providence, R. I. 305.9m-980kc. 500 watts. The Outlet Co. Announcer, J. A. Rolly. Slogan, "The Southern Gateway of New England." Daily ex Sun, 1:05-2:15 pm, weather, reports, music. Mon, Wed, Fri, 10:45 am, household hints. Mon, 7:30-11 pm. Tues, 7:30-10 pm. Wed, 7:30-10:30 pm, Thurs, 7:45-11 pm. Fri, 7:30-10 pm, 11-12. Sun, 7:20-10:15 pm. Eastern.
- WJAS**, Pittsburgh, Pa. 275.1m-1090kc. 500 watts. Pittsburgh Radio Supply House. Pickering's Studio. Announcer, Bryan McDonald. Slogan, "World's Jolliest Aerial Station." Daily ex Sun, 7-8 pm, dinner concert; 8-11. Sun, 2 pm. Eastern.
- WJAX**, Jacksonville, Fla. 336.9m-890kc. 1000 watts. City of Jacksonville.
- WJAZ**, Chicago, Ill. 322.4m-930kc. 1,500 watts. Zenith Radio Corp. Announcer, E. F. McDonald, Jr. Wed, Sat, 9-2 am. Thurs, 10-12 midnight. Sun, 7-9 pm. Central.
- WJBA**, Joliet, Ill. 206.8m-1460kc. 50 watts. D. H. Lentz, Jr. Tues, Thurs, Sat, 7-12 midnight. Central.
- WJBB**, St. Petersburg, Fla. 254.1m-1180kc. 10 watts. L. W. McClung.
- WJBC**, I. Salle, Ill. 234.2m-1280kc. 100 watts. Hummer Furniture Co. Announcer, Harry Halpin. Daily ex Sun, 12:30-1 pm. Mon, 8-11 pm. Central.
- WJBG**, Charlotte, N. C. 223.7m-1340kc. 10 watts. Interstate Radio, Inc.
- WJBI**, Red Bank, N. J. 218.8m-1370kc. 250 watts. Robert S. Johnson.
- WJBK**, Ypsilanti, Mich. 232.4m-1290kc. 100 watts. Ernest F. Goodwin.
- WJBL**, Decatur, Ill. 270.1m-1110kc. 500 watts. WH-Gusard Dry Goods Co. Announcer, H. B. Rickards. Mon, Wed, Sat, 9:30-11 pm. Central.
- WJBP**, Buffalo, N. Y. 218.8m-1370kc. 50 watts. Seneca Vocational School.
- WJBQ**, Lewisburg, Pa. 211.1m-1420kc. 100 watts. Bucknell University. Slogan, "In the Heart of the Keystone State."
- WJJD**, Moosehart, Ill. 370.2m-810kc. 1,000 watts. Loyal Order of Moose station. Announcer, Jack Nelson. Slogan, "The Call of the Moose." Daily ex Sun, Mon, 12-1 pm, 2:30; 4-5 pm, children's program; 6-7 pm, 10-11, 12:30-2 am. Sun, 7:45-8:40 am, service; 9:45-11 am, services; 3-4. Central.
- WJR**, Pontiac, Mich. 516.9m-580kc. 5,000 watts. Jewett Radio and Phonograph Co. Slogan, "Where Joy Reigns." Announcer, Leo Fitzpatrick. Daily ex Sun, 7-8 pm, 9-10. Thurs, Sat, 10-11 pm. Mon, Wed, Sat, 11:30-1 am. Eastern.
- WJY**, New York City. 405.2m-740kc. 5,000 watts. R. C. A. Announcer, J. Lewis Reid. Tues, Thurs, Fri, 7:30-11:30 pm, concert. Sun, 8:15-10:30 pm. Eastern.
- WJZ**, New York, N. Y. 454.3m-660kc. 5,000 watts. R. C. A. Announcer, Milton J. Cross. Daily ex Sun, 10-11 am, 1-2 pm, 4-6, entertainment; 7-11:30 pm, special program. Sun, 11-1 pm, church services; 2:30-5 pm, 7-10:30 pm. Eastern.
- WKAF**, Milwaukee, Wis. 260.7m-1150kc. 500 watts. Kesselman-O'Driscoll-Hotel Antlers. Announcer, Robert F. Hall Co. Mon, Wed, Fri, 10-11 pm; Thurs,

FRESHMAN *Announces!* Another Sensation!

MODEL 6-F-1 New and Improved **FRESHMAN MASTERPIECE**

The World's Greatest Radio Receiving Set

Freshman's latest sensation, illustrated here, has a real appeal to the women of the home. It is built of five-ply genuine mahogany; a handsome piece of furniture that fits in any corner of any sized room. It is compact and comparatively small, giving it preference over clumsy consoles. Contains an especially large tone chamber,

**With Built-in Loud Speaker of Great Volume
and Superb Tone**

When not used as a radio, this console can be entirely closed. The top is stationary and provides an attractive resting place for vases and other ornaments. Spacious compartments afford ample room for all batteries, etc.—not a single wire being visible.

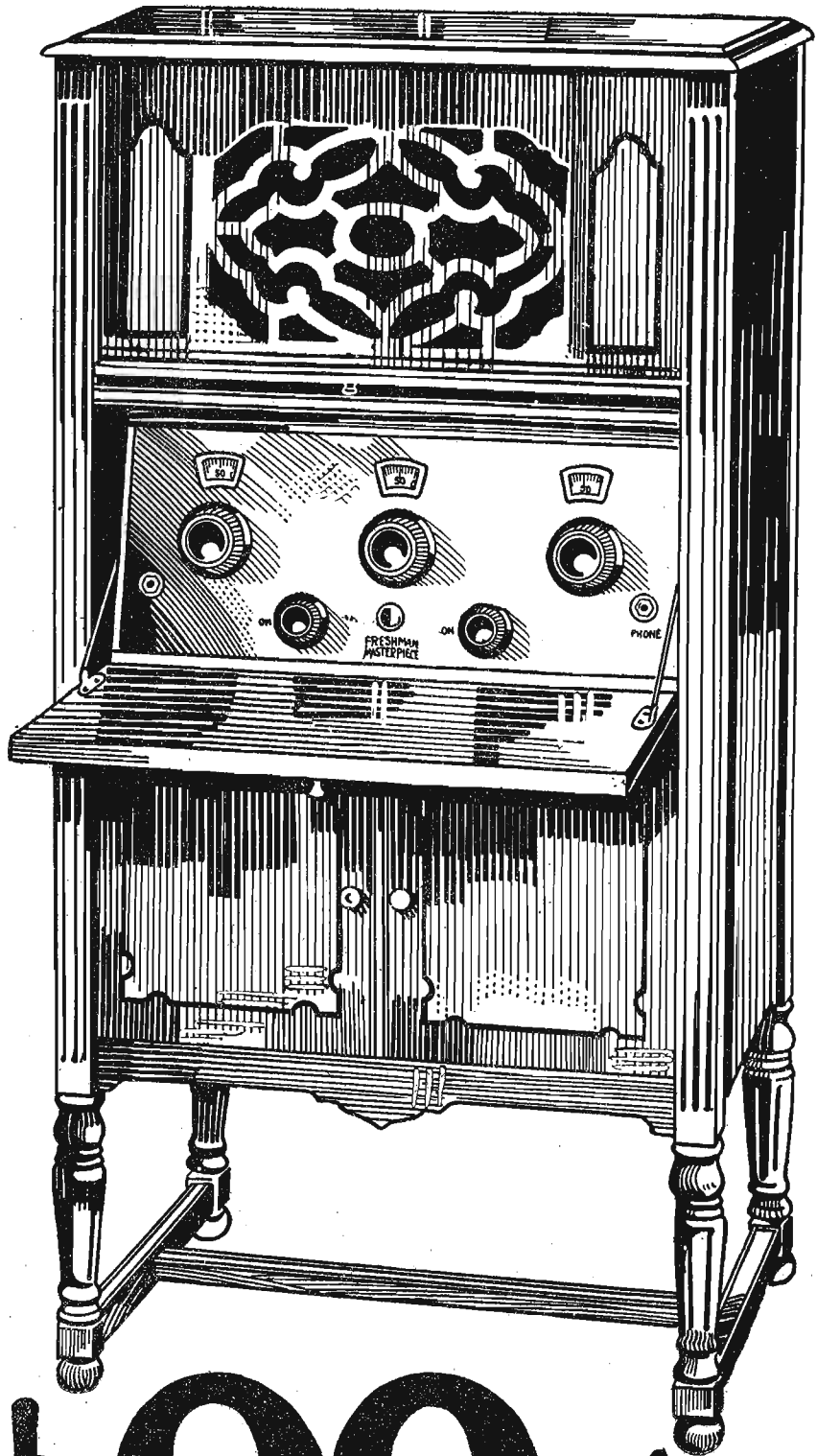

The Radio Receiver Women Have Been Waiting For

Here you see Model 6-F-1 entirely closed—real furniture for which no home is too pretentious and none too modest to afford.

Write for free illustrated booklet, describing this handsome console in detail.

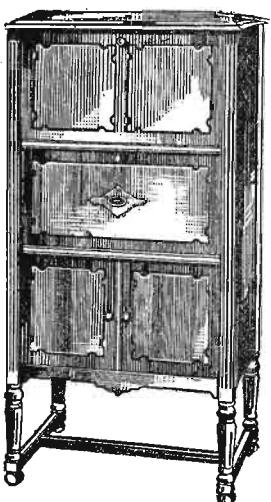

CHAS. FRESHMAN CO., INC.
Freshman Building
2626 W. Washington Blvd.
New York
Chicago

\$ 99.50

Sold on Convenient Terms by Authorized Freshman Dealers, Who Also Install and Service Them.